

WIRELESS FLEX DIMMING CONNECTIVITY KIT FOR SHYFT LIGHT SCHEDULER

USER & INSTALLATION GUIDE AMERICAS

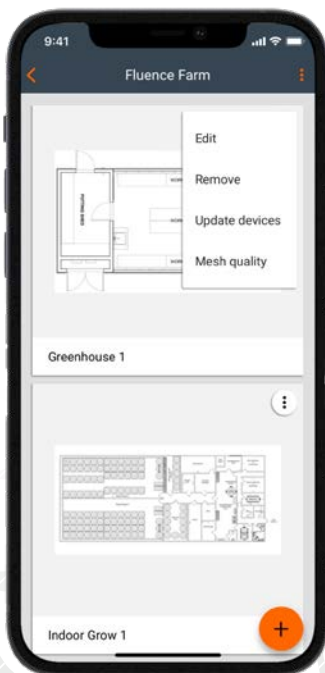

CONTENTS

All of the contents are protected from copying under the provisions of copyright laws. The copyrights belong to Fluence and Signify. Any unauthorized copying, alteration, distribution, transmission, performance, display, or other use of this material is prohibited.

1. INTRODUCTION.....	3
1.1 CONFIRM CONNECTIVITY KIT CONTENTS AND ACCESSORIES.....	5
1-ZONE CONNECTIVITY KIT (WFDM-SHYFT-1ZONE).....	5
2-ZONE CONNECTIVITY KIT (WFDM-SHYFT-2ZONE).....	5
ADDITIONAL WIRELESS FLEX DIMMING RECEIVERS (SOLD SEPARATELY).....	5
1.2 WIRELESS FLEX DIMMING LIGHT FIXTURE / POWER SUPPLY COMPATIBILITY.....	6
2. HARDWARE INSTALLATION.....	7
2.1 WIRELESS FLEX DIMMING RECEIVER.....	7
2.2 SHYFT WIRELESS FLEX DIMMING ADAPTER AND 0-10V WIRELESS ADAPTERS.....	8
3. COMMISSIONING READINESS CHECKLIST.....	12
3.1 WIRELESS FLEX RECEIVER.....	12
3.2 SHYFT WITH 0-10V WIRELESS ADAPTERS.....	13
4. COMMISSIONING PROCEDURE.....	14
5. COMMISSIONING APPS AND PRODUCT INFORMATION.....	22
6. SYSTEM DIAGRAM.....	23
7. CONTACT INFORMATION.....	24

1. INTRODUCTION

Thank you for choosing the Fluence Wireless Flex Dimming Connectivity Kit for SHYFT Light Scheduler! Fluence Wireless Flex Dimming utilizes qualified Bluetooth® mesh technology enabled by SILVAIR for wireless control of Fluence luminaires.

GLOSSARY OF TERMS

Please read first to become familiar with terms that you will see in Wireless Flex Dimming.

Device: A Fluence Wireless Flex Dimming 0-10V Adapter or Receiver. Also referred to as a Node.

Control Zone: A group of devices that are controlled together. A single Zone or multiple linked Zones in the Fluence Wireless Flex Apps is a Control Zone.

Channel: A single 0-10V dimming output on a controller or dimmer. One Channel controls one Control Zone.

Relay: A Bluetooth node which can repeat any signals that it receives to nearby nodes.

Hops: Bluetooth wireless communication travels from relay to relay. A hop is a transmission from one relay to another.

Mesh Networking: A mesh network supports multiple paths from point A to point B, allowing for large networks over a long distance.

Fluence Wireless Flex uses a three-tiered hierarchical structure for mapping devices to their physical location: **Project → Area → Zone**

Project: The top-level grouping, a Project typically denotes an independent installation like a facility or building. It can also represent a single room or floor for smaller installations. Each user can create multiple projects as required. Each project can have a maximum of 8,000 to 10,000 devices.

Area: The mid-level grouping, an Area typically denotes a floor of a building or a house or bay in a greenhouse. Each Project can have 40 – 50 areas. We recommend 200 devices maximum per area, although up to 300 are supported. All devices in an area can be controlled together if desired (through zone linking), but each individual zone can also be controlled separately.

Zone: The lowest-level grouping; all devices in a Zone are controlled together. We recommend 20 – 30 devices per zone. Each project can have up to 2,000 zones.

1. INTRODUCTION

Use the following simple procedure to install and commission Wireless Flex Dimming with SHYFT Light Scheduler if:

- There are less than 30 devices per control zone.
- The distance from the SHYFT Light Scheduler location to the furthest Wireless Flex Dimming Receiver in the control zone is no more than 50 ft (15.24 m) with no obstructions in between them, or 30 ft (9.1 m) with obstructions like walls, metal posts, or metal racks.

If there are more devices per control zone and/or with longer distances, the installation will require further planning and additional commissioning steps. In this case, please also refer to the following guides:

Wireless Flex Dimming Hardware Installation Guide

Wireless Flex Dimming External Relay Implementation Guide

Wireless Flex Apps Quick-Start Commissioning Guide

Wireless Flex Dimming Apps Commissioning Guide (full reference for additional functions and features not listed in this guide, and troubleshooting)

All are available for download at: <https://fluence.science/products/wireless-flex-dimming/>.

The installation process consists of two parts:

Part 1: Hardware Installation

Part 2: Commissioning via software apps

Fluence Wireless Flex mobile app for On-site Commissioning

System Requirements:

- iOS device with iOS 12 or higher
- Google Chrome web browser v.70 or higher (required to activate your Fluence Wireless Flex account)
- Bluetooth enabled on iOS device
- Internet data connection (WiFi or cellular, minimum 3G)

Be sure to check in advance if a WiFi or cellular internet connection is available in the location of your SHYFT Light Scheduler and light fixtures. The Internet connection is only required during commissioning.

Fluence Wireless Flex Web App for Off-site Planning

System Requirements:

- Microsoft Windows or Apple computer
- Google Chrome web browser v.70 or higher
- Internet data connection

CHEMICAL EXPOSURE PRECAUTION

Fluence lighting systems are designed to be resilient against crop protection products. Many chemicals used in the Commercial Horticultural Industry are corrosive to electronic equipment. Care should be taken to ensure that only approved crop protection products, cleaning agents and/or other chemicals (e.g., pesticides, fungicides and insecticides) may come in contact with the device. If the device is accidentally exposed to a corrosive liquid or vapor (e.g. VOC –Volatile Organic Compound and H₂S – Hydrogen Sulfide) the device must be rinsed with clean water as soon as possible. The product warranty will no longer apply if the product is repeatedly exposed or remains in the corrosive environment for a prolonged period. It is recommended the devices be removed and protected from the corrosive environment during all periods of aggressive disinfection or sanitization of the facility. The product warranty will be void if the product is repeatedly exposed to Sulfur.

1. INTRODUCTION

1.1 CONFIRM CONNECTIVITY KIT CONTENTS AND ACCESSORIES

Please confirm the contents of your Connectivity Kit and quantify of light fixture power supplies to ensure that you have everything you need before you begin. (1) 0-10V Adapter is required for each control zone, and (1) Receiver is required for each light fixture power supply.

SHYFT Light Scheduler (CTLA-SHYFT) and additional Wireless Flex Dimming Receivers are sold separately. The Receiver included with the Connectivity Kit has a metal M12 Dimming Port connector. If your light fixture power supply has a plastic M16 Dimming Port, you will need to purchase a compatible Receiver. Please refer to the “Additional Wireless Flex Dimming Receivers (sold separately)” and “Fluence Light Fixture/Power Supply Compatibility” tables below.

CONNECTIVITY KIT CONTENTS

Descriptions		Ordering Code	1 ZONE	2 ZONE
A	Wireless Flex Dimming Adapter for SHYFT	WFDM-SHYFT-ADPT	1	1
B	Wireless Flex 0-10V Adapter*	WFDM-10539-01	1	2
C	Wireless Flex Dimming Receiver for Fixture with M12 dimming port	WFDM-10538-01	1	2
D	Wireless Flex Dimming Adapter for SHYFT Dust Cap	WFDM-M16-DUSTCAP	1	N/A







ADDITIONAL WIRELESS FLEX DIMMING RECEIVERS (sold separately)

Descriptions	Ordering Code	Quantity Included
A Wireless Receiver for Light Fixture Power Supply with metal M12 Dimming Port	WFDM-10538-01-AR	1
B Wireless Receiver for Light Fixture Power Supply with plastic M16 Dimming Port	WFDM-10537-01	1



1. INTRODUCTION

1.2 WIRELESS FLEX DIMMING LIGHT FIXTURE / POWER SUPPLY COMPATIBILITY

Fluence Light Fixture	Dimming Port	Wireless Flex Dimming Receiver
<p>VYPR 2p, 2x2 / 120-480V VYPR 2x / 120-400V</p> <p>VYPR 3p, 3x2 / 120-480V VYPR 3x / 120-400V</p> <p>SPYDR 2h, 2i, 2p / 120-480V SPYDR 2x / 120-480V SPYDR Fang 120-277V (replaces included dimmer)</p> <p>RAZR Modular / 120-480V RAPTR / 277-480V</p>	<p>M12</p> 	<p>WFDM-10538-01 WFDM-10538-01-AR Metal Threaded /M12 Female/3-pin</p> 
<p>VYPR 2p, 2x, 2x2 / 120-480V VYPR 3x / 480V</p> <p>SPYDR 2i, 2p, 2x / 120-480V</p>	<p>M16</p> 	<p>WFDM-10537-01* Plastic Push-Lock/M16 Female/3-pin</p> <p>*SOLD SEPARATELY</p> 
<p>VYNE, RAY, RAZR 2/3/4, RAZRx, SPYDRx/PLUS, VYPRx</p>		<p>NOT COMPATIBLE</p>

2. HARDWARE INSTALLATION

2.1 WIRELESS FLEX DIMMING RECEIVER

Install a Wireless Flex Dimming Receiver on each Fluence light fixture/power supply.

STEP 1:

Remove the dust cap from the light fixture power supply dimming port. The dimming port is the 3-pin connector located on the DC end of the power supply next to the 2-pin DC fixture power port that connects to the luminaire. Install the correct Wireless Flex Receiver on the Fluence light fixture dimming port per Figure A or B.

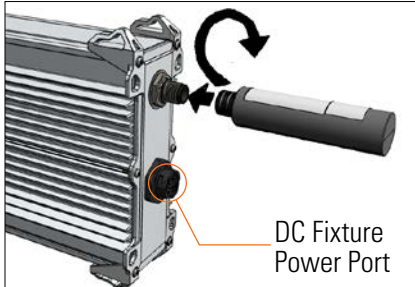

A. M12 (Metal) Dimming Port

Line up the pins and push in. Screw the locking ring clockwise until hand tight. To remove, unscrew the locking ring counterclockwise until loose and pull out.

M12 (Metal) Dimming Port

WFDM-10538-01

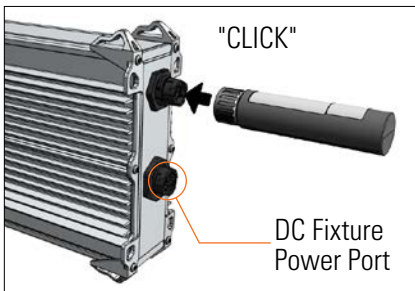

B. M16 (Plastic) Dimming Port

Line up the pins and push on until it clicks. To remove, twist the locking ring a quarter turn counterclockwise and pull out.

M16 (Plastic) Dimming Port

WFDM-10537-01



IMPORTANT: Ensure that the cable for the DC Fixture Power Port is run away from the Wireless Flex Receiver. The cable should not come closer to the Receiver than the distance between the DC Fixture Power Port and the Dimming Port.

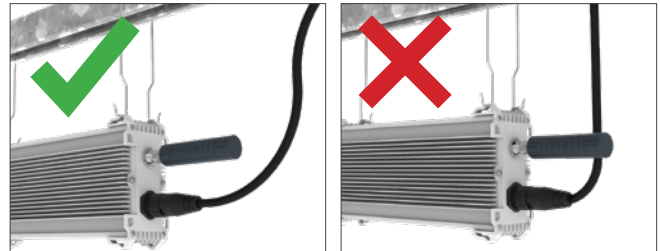

STEP 2:

Remove the tear-off portion of the product label and use it to mark the installation location on a site map for future reference. This will assist in identification during commissioning. Commissioning worksheets are available at <https://fluence.science/support-center/>



CAUTION: The tear-off portion of the label must be removed prior to final installation. The tear-off portion could possibly detach and fall off over time if not removed.

STEP 3:

Repeat Steps 1-2 for each Fluence light fixture in the installation. Receivers can be installed at any point during or after light fixtures are installed. An uncommissioned Receiver will set the light fixture's level to 100% brightness.

2. HARDWARE INSTALLATION

2.2 SHYFT WIRELESS FLEX DIMMING ADAPTER AND 0-10V WIRELESS ADAPTERS

STEP 1:

Install the SHYFT Wireless Flex Dimming Adapter to SHYFT Light Scheduler

A Lay the SHYFT unit face-down on a flat surface, on a thick cloth or bubble wrap to protect the screen. Open and remove the cover on the back of SHYFT Light Scheduler by gently pulling up on the two bottom tabs until the hatch is free. This may require some force, so place your hands on top for leverage and use your thumbs to pull up on each tab.



B Remove the silicone gasket from SHYFT and insert the wires and tubes of the SHYFT WFD adapter through the two larger gasket sleeves as shown. Pull the gasket sleeves down over the wire tubes until they are below the top wide flanges as shown.

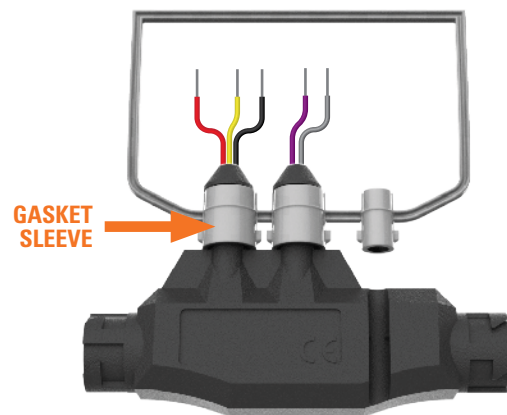

CONNECTION TERMINALS

Terminal	Descriptions	Component	Wire Color
A	12 V DC +	SHYFT WFD Adapter	Red
B	Channel (Zone) 2 Dim +		Yellow
C	Channel (Zone) 2 Dim -		Black
D	Channel (Zone) 1 Dim +		Purple
E	Channel (Zone) 1 Dim -		Gray
F	DC Input Power 15 V DC +	AC-DC Power Adapter	Red
G	DC Input Power 15 V DC -		Black

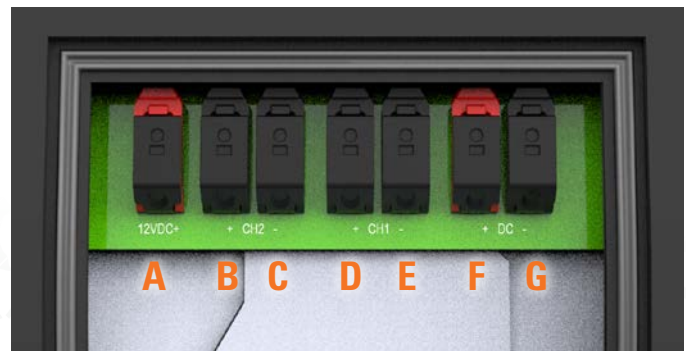

2. HARDWARE INSTALLATION

2.2 SHYFT WIRELESS FLEX DIMMING ADAPTER AND 0-10V WIRELESS ADAPTERS

STEP 1: CONTINUED

- C** Insert each wire in the terminals per the wiring table above. Start from left to right. Use a small flat head screwdriver to gently press and hold down the wire terminal button while inserting the wire, then release the button after the wire is in place.

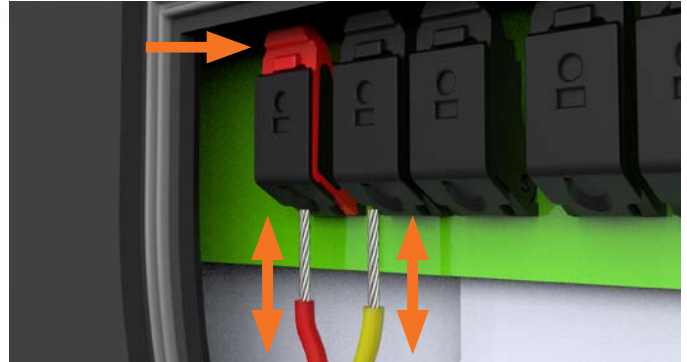

- D** Insert the AC-DC power adapter cable through the smaller gasket sleeve and pull it through far enough to reach the terminals. Insert the wires in the terminals per the wiring table above. Insert AC-DC power adapter cable into the slot on the SHYFT WFD adapter.

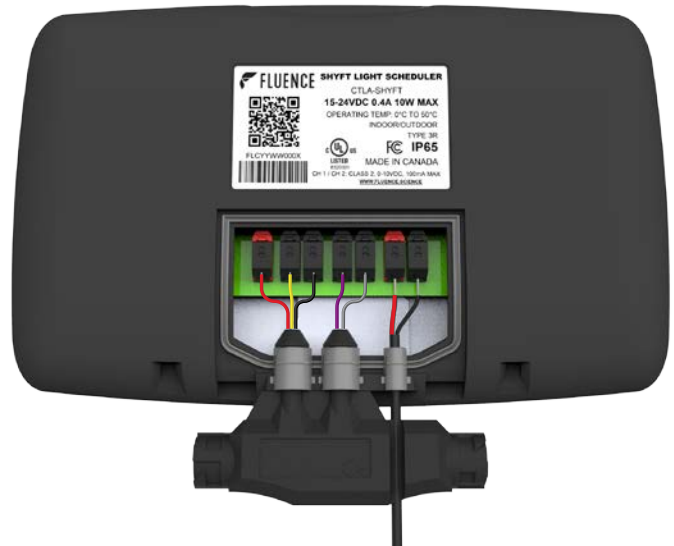

- E** Ensure the tubes and cable are fully through gasket sleeves. Properly seat the sleeves and thin part of the gasket in the grooves around the wiring compartment as shown to ensure a water-tight seal.

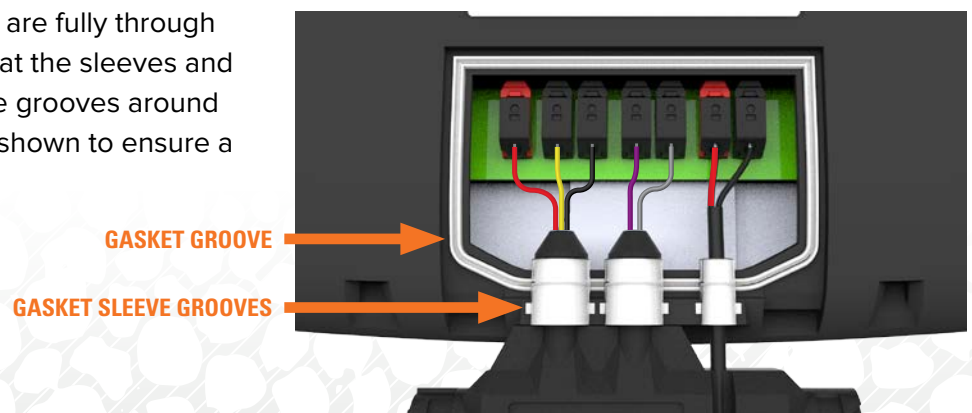

2. HARDWARE INSTALLATION

2.2 SHYFT WIRELESS FLEX DIMMING ADAPTER AND 0-10V WIRELESS ADAPTERS

STEP 1: CONTINUED

- F** Insert the top of the cover into the body and push forward, and then press down on the bottom of the cover until it audibly snaps securely into place. This may require some force, so place your hands on top for leverage and use your thumbs to push down at each tab.



- G** Mount the SHYFT unit per the SHYFT Light Scheduler User & Installation Guide. Carefully lower the bottom of the unit onto the mounting bracket (shown in red for visibility), aligning the two tabs on the bracket into the two slots on SHYFT. With the bottom of the unit seated on the bracket tabs, push the top of the unit into the bracket until the top audibly snaps in.



2. HARDWARE INSTALLATION

2.2 SHYFT WIRELESS FLEX DIMMING ADAPTER AND 0-10V WIRELESS ADAPTERS

STEP 2:

Install the 0-10V Wireless Adapter(s) on the SHYFT Wireless Flex Dimming Adapter

- A** Line up the 0-10V Adapter pins on the CH 1 (Zone 1) port as shown and push it on while holding the SHYFT adapter, until it clicks.

For 1-Zone Connectivity Kits, install the included dust cap on the unused port.

NOTE: To remove the 0-10V Adapters, twist and hold the locking ring a quarter turn counterclockwise while pulling out.



- B** For 2-Zone Connectivity Kits, repeat Step 2A on CH2 (Zone 2) and install a 0-10V Adapter on the second connector port.



Remove the tear-off portion of the product label and use it to mark the installation location on a site map or list for future reference. This will assist in identification during commissioning. Commissioning worksheets are available at <https://fluence.science/support-center/>

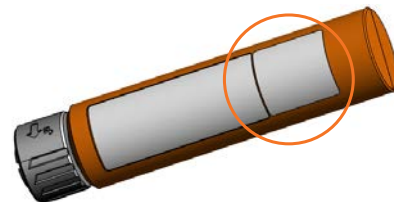

CAUTION: The tear-off portion of the label must be removed prior to final installation. The tear-off portion could possibly detach and fall off over time if not removed.

2. HARDWARE INSTALLATION

2.2 SHYFT WIRELESS FLEX DIMMING ADAPTER AND 0-10V WIRELESS ADAPTERS

STEP 2: CONTINUED

- C** Complete the installation of SHYFT and perform the initial setup per the ***SHYFT Light Scheduler User & Installation Guide***. Plug in the AC power adapter of SHYFT Light Scheduler to power the unit and Wireless 0-10V Adapters, and then complete the SHYFT initial setup.



IMPORTANT: The light control will not function until after Wireless Flex Dimming is commissioned using the Wireless Flex apps. If you must turn the lights off before this is completed, switch off power to the lighting circuit.

3. COMMISSIONING READINESS CHECKLIST

3.1 WIRELESS FLEX RECEIVERS

- All Wireless Flex Dimming Receivers are installed per Section [2.1 Wireless Flex Receiver](#).
- Verify that all light fixtures are powered on at 100% brightness



3. COMMISSIONING READINESS CHECKLIST

3.2 SHYFT WITH 0-10V WIRELESS ADAPTERS

- SHYFT, the WFD Adapter, and 0-10V Wireless Adapters are installed per [Section 2.2 SHYFT Flex Dimming Adapter and 0-10V Wireless Adapters](#), and the **SHYFT Light Scheduler User & Installation Guide**.
- Power SHYFT Light Scheduler and verify that the blue status LED (the LED may appear white) at the end of each Wireless Flex 0-10V Adapter is illuminated and blinking fast. If the status LED is not blinking, the 0-10V Adapter is not powered.



0-10V ADAPTER AND RECEIVER STATUS LED:

- **No Blinking:** device is not powered
- **Fast Blinking:** not connected to the network
- **Slow Blinking:** connected to a network



IMPORTANT: If the LED is blinking slowly and you have not yet commissioned the device, it must be reset to factory defaults or it will not be found during the device search to connect to your mesh network. While the device is powered, hold a magnet to the center of the housing for 10 seconds.

When all items in the checklist are completed, the Wireless Flex Dimming installation is ready for commissioning!

4. COMMISSIONING PROCEDURE

BEFORE YOU BEGIN

Download the free iOS app to your Apple phone or tablet. Scan the QR code or search “Fluence Wireless Flex” in the Apple app store.

The Fluence Wireless Flex mobile app requires an iOS device with iOS 12 or higher and Bluetooth enabled, as well as an Internet connection (WiFi or cellular, minimum 3G). Google Chrome web browser v.70 or higher is required to activate your Fluence Wireless Flex account.

Be sure to check in advance if a WiFi or cellular internet connection is available in the location of your SHYFT Light Scheduler and light fixtures. The Internet connection is only required during commissioning.

Mobile App



<https://apps.apple.com/us/app/fluence-wireless-flex/id1558821999>

STEP 1:

Create an account and log in.

Open the Fluence Wireless Flex app and tap **SIGN UP**. Enter the required information, check “I accept and agree” to the terms, and then tap **SIGN UP** at the bottom. You will receive an activation email. Check your junk/spam or quarantine folder if you do not receive the email within 5 minutes. **If Google Chrome is not your default web browser, copy the “Confirm” button link from the email, and paste into Chrome and go.** Follow the instructions to activate your account. Return to the Wireless Flex mobile app and tap LOG IN, and then log in using your account email and password.

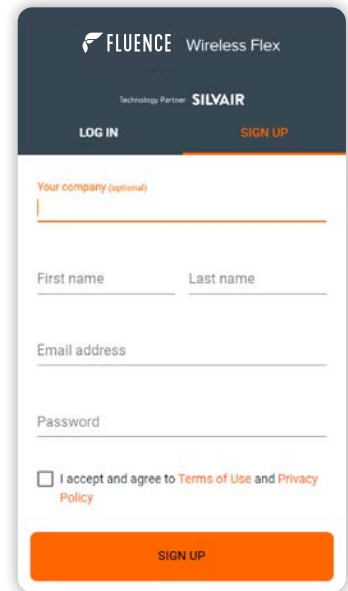
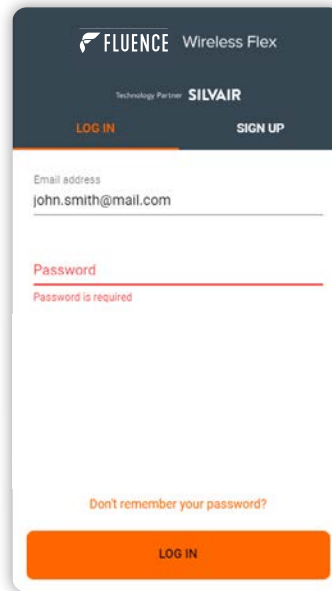

4. COMMISSIONING PROCEDURE

STEP 2:

Create a Project

Tap the  icon to create a project. Name it “SHYFT” for example, and then tap CREATE.

TIP: If you have more than one SHYFT Light Scheduler with Wireless Flex Dimming, create a separate Project for each SHYFT and give each a unique name. Then repeat Steps 3 - 5 for each one.

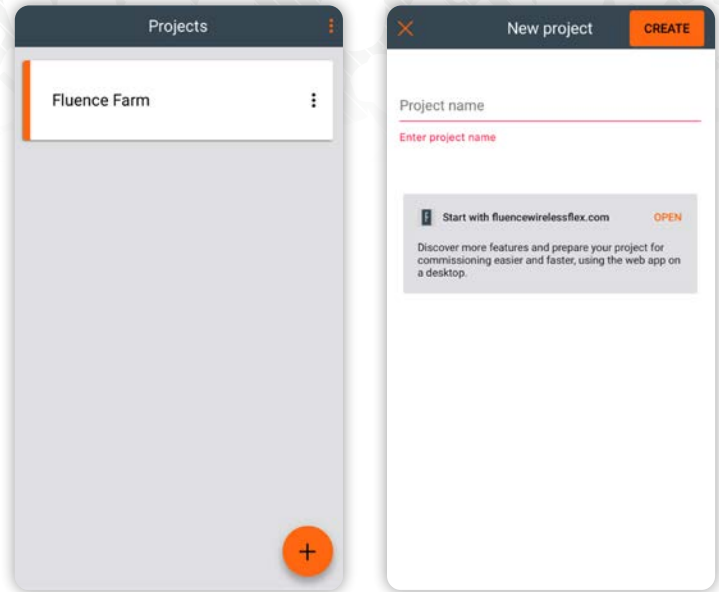

If you need to remove a Project, all devices must first be removed from all Zones. Tap the  icon to the right of the Project, and then tap REMOVE. Tap the REMOVE button to remove the Project.

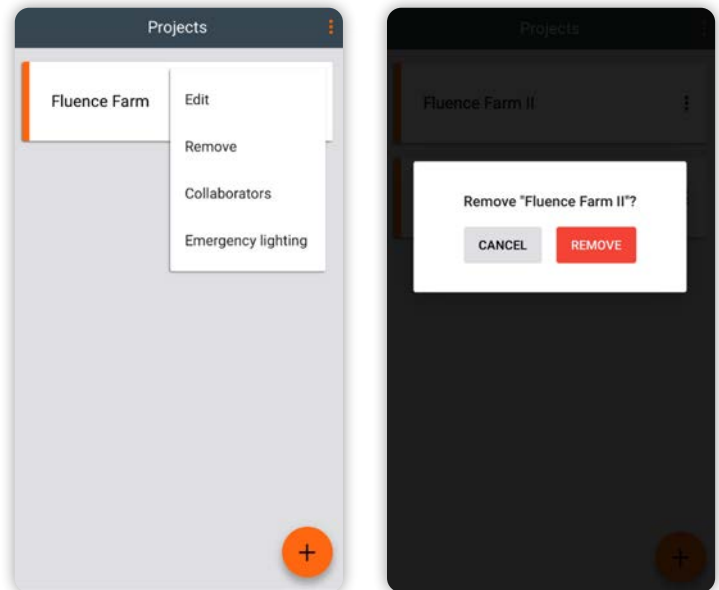



4. COMMISSIONING PROCEDURE

STEP 3:

Create an Area.

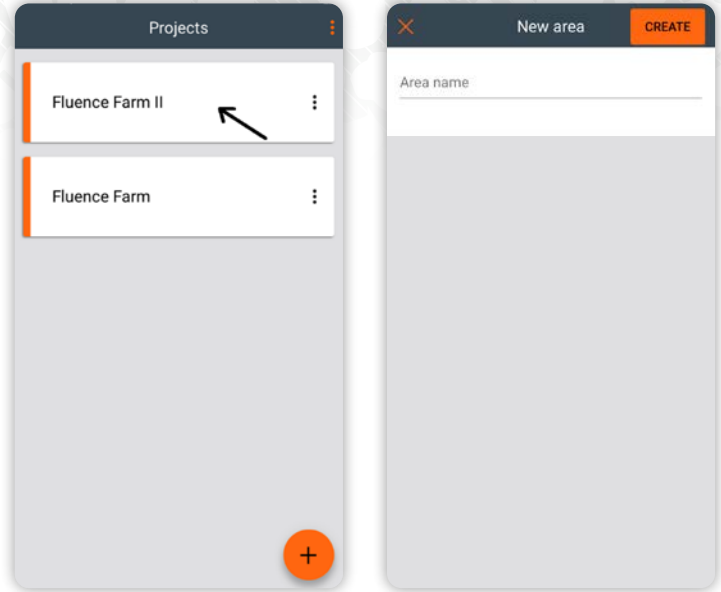
After the Project is created, tap on the Project. Tap the  icon to create an Area. Name it "WFD" for example, and then tap **CREATE**.



If you need to remove an Area, all devices must first be removed from all Zones. Tap the  icon to the right of the Area, and then tap **REMOVE**. Tap the **REMOVE** button to remove the Area.

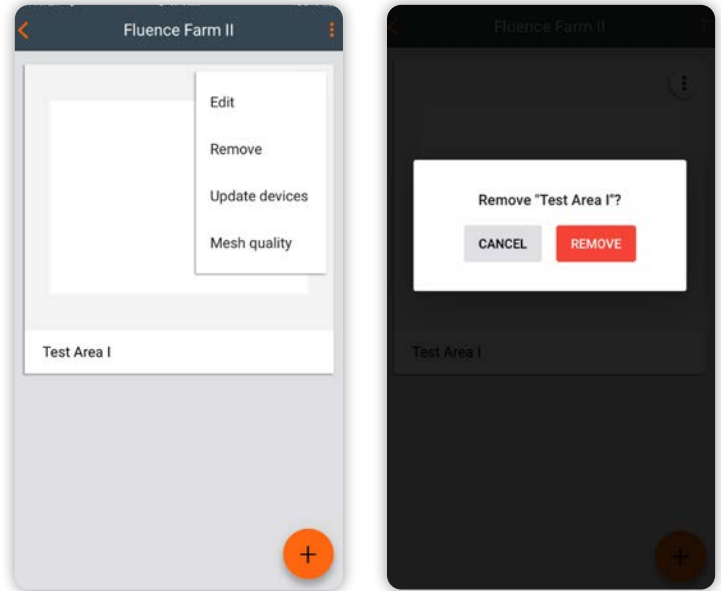

4. COMMISSIONING PROCEDURE

STEP 4:

Create Zones.

- A** After the Area is created, tap on the Area. Tap the **+** icon to create a Zone. Name it “Channel 1” for example. Select the **P1. Horticulture Lighting** profile, and then tap **CREATE**.

You can view the name of the Zone by tapping the **⋮** icon at the top right of the screen, and then tap “Show Labels”.

- B** If you have a 2-Zone Connectivity Kit, create a second Zone. Name it “Channel 2” for example. Select the **P1. Horticulture Lighting** profile, and then tap **CREATE**.

Tip: If you don't see the second Zone, press and hold Zone 1 for 2 seconds and then drag it across the screen until it's visible.

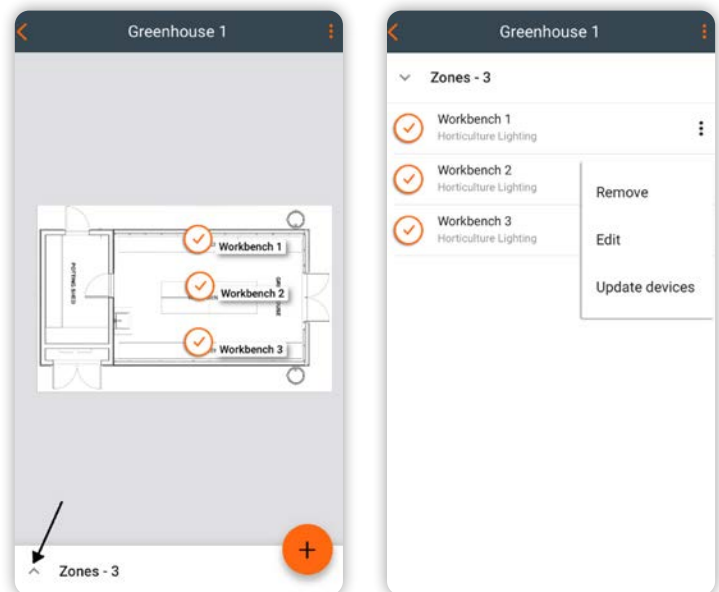
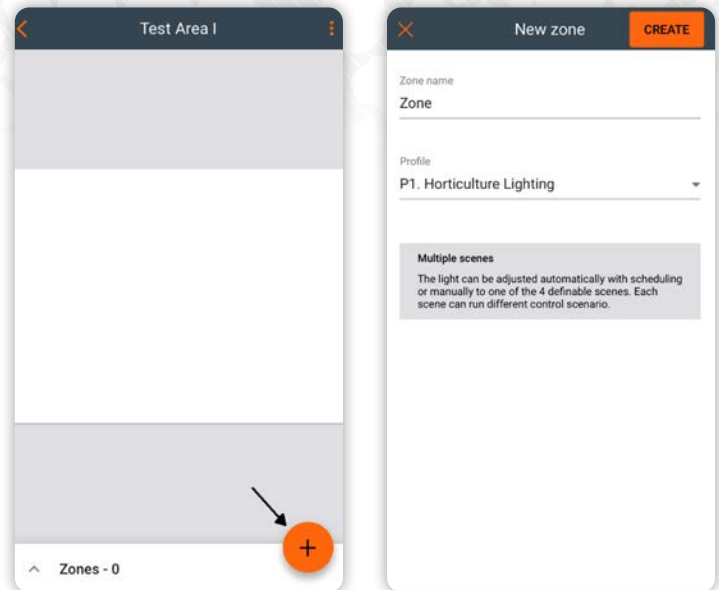

If you need to remove a Zone, all devices must first be removed from the Zone. Tap the Zones list on the bottom left of the screen. Tap the **⋮** icon to the right of the Zone, and then tap **REMOVE**. Tap the **REMOVE** button to remove the Zone.



4. COMMISSIONING PROCEDURE

STEP 5:

Add Devices to the Zones:

- A** Tap on the  icon for Zone 1. You will see that this Zone is empty.
- B** Tap on the  icon on the lower right to begin searching for devices. Move the slider at the bottom all the way to the right to “ALL”. A list of the Wireless Flex Dimming 0-10V Adapters and Receivers will appear after a few moments.
- C** Identify the devices. Devices can be identified in one of two ways, visually or by device label.

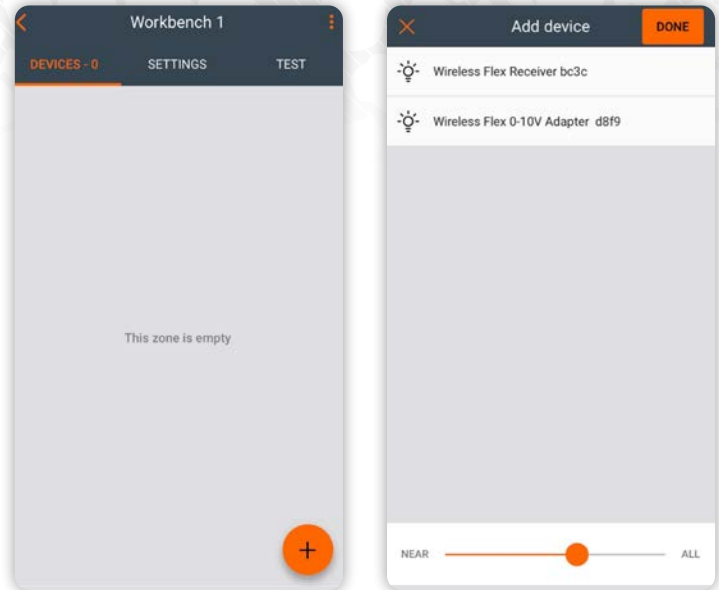

VISUAL IDENTIFICATION

When a Receiver device is tapped and selected on the list the light fixture will begin to flash. When a 0-10V Adapter is selected the blue status LED (the LED may appear white) on the end of it will change from blinking fast to blinking slowly.

The flashing of the light fixture or LED may be difficult to see in certain conditions, so it is recommended to identify by device label.

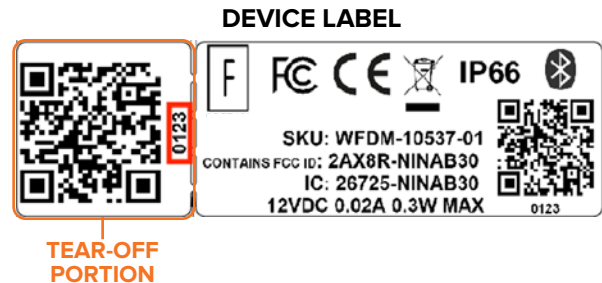

IDENTIFICATION BY DEVICE LABEL

The 0-10V Adapter and Receiver have a label with a tear off portion. The alpha-numeric address that matches the label will appear at the end of the device description in the mobile app. If you placed this label on a location map or list during installation, you can easily identify it to add it to the correct Zone.

Commissioning worksheets are available at <https://fluence.science/support-center/>

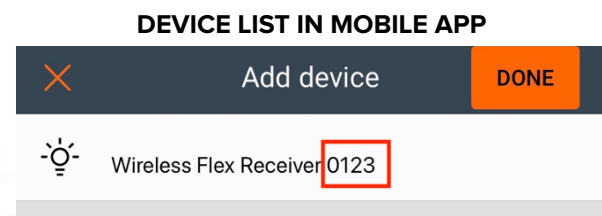

4. COMMISSIONING PROCEDURE

STEP 5: CONTINUED

Add Devices to the Zones.

D If the device selected is correct for the Zone, tap **ADD**. If it belongs to Zone 2 you can tap **Add the device to another zone** at the bottom, and it will take you back to the Area. Tap on the Zone 2 **+** icon and then tap **ADD**. You can also tap **CANCEL** to return to the device list to select a different device.

A spinning progress bar will appear at the top. When done you will see “1” next to “Completed”, and the number will increase as you commission more devices to that Zone.

NOTE: If it failed to add the device, tap **TRY AGAIN**. If it continues to fail after several attempts tap **CANCEL**, check the device, and then repeat Steps 5B through 5D.

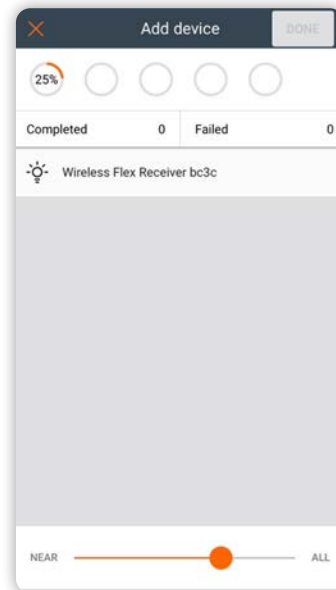
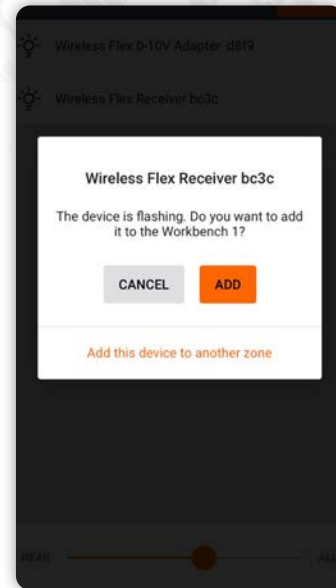



4. COMMISSIONING PROCEDURE

STEP 5: CONTINUED

Add Devices to the Zones.

E Repeat Steps 5B through 5D until all devices are commissioned. No devices will appear in the Add Device search list when all 0-10V Adapters and Receivers are commissioned. Use the back arrow at the upper left to return to the Area.

If you need to remove a device from a Zone, tap the Zone  icon. Tap on the device in the list, and then tap the trash can icon. Tap on **REMOVE** (or when the **REMOVE PROXY** button turns orange) to remove the device.

Return to the Area. All Zones in the Area should now display a check mark icon. 

If there is an exclamation mark , tap on it, then tap **CONFIGURE ALL**. This should correct the issue.

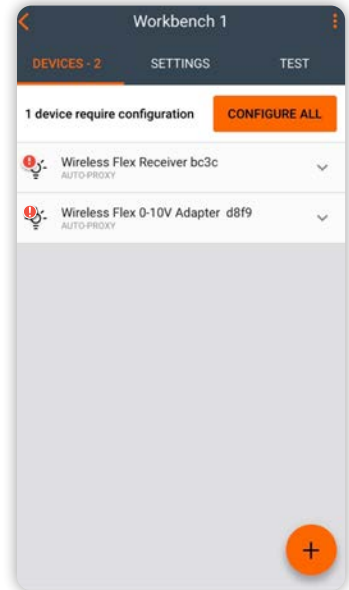
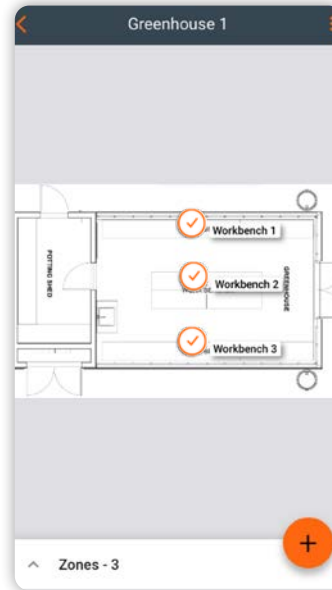
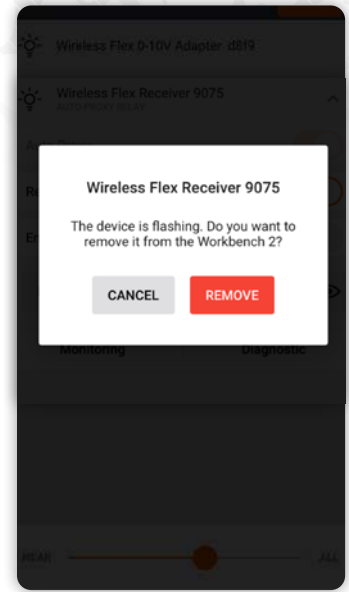
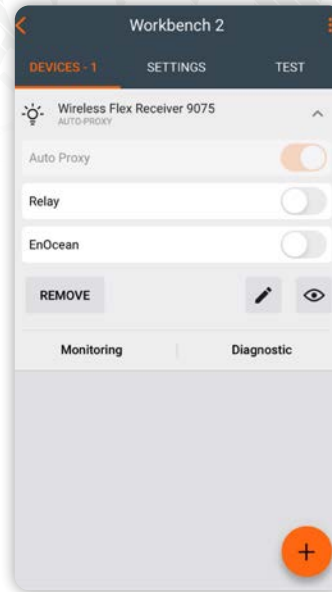

4. COMMISSIONING PROCEDURE

STEP 6:

Test the Installation

- A** Tap the Zone  icon, and then tap **TEST** above the list of devices. Tap the various buttons and move the “ALL LUMINAIRES” slider to test the light fixtures in the entire Zone. You can test an individual light fixture by moving the slider on a specific device.

TIP: The Test function in the Fluence Wireless Flex mobile app can be used as an alternate means to control the lights in the event that SHYFT Light Scheduler encounters a problem, or if one is not connected.

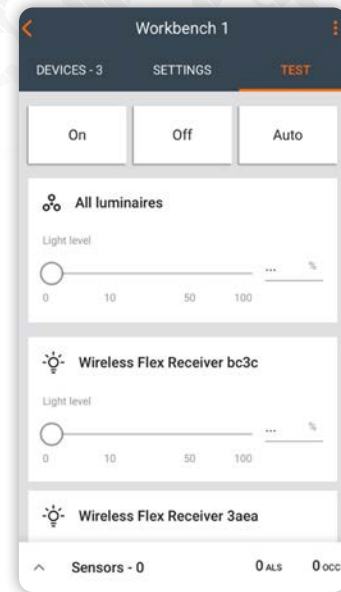

- B** Test your light fixtures via SHYFT Light Scheduler using Manual Mode on each channel. Go to the Main Menu, tap Manual Mode, and then tap **DONE**. Drag the slider to dim the lights up and down, and then to 0 to turn off. Tap **SAVE & EXIT** to go back to the Main Menu to switch channels.

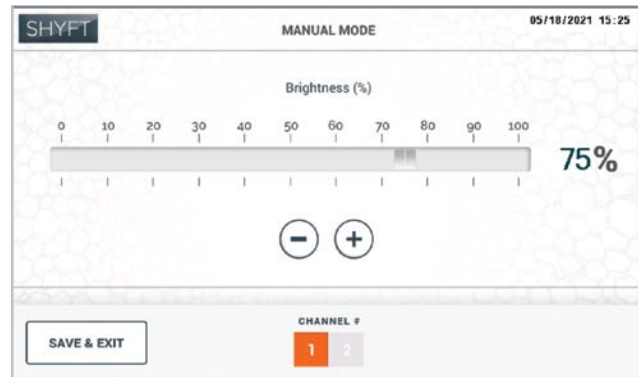

The installation is now complete!

If you encounter any issues while commissioning Wireless Flex Dimming, please refer to the **Wireless Flex Apps Quick-Start Commissioning Guide** and **Wireless Flex Apps Commissioning Guide** full reference for troubleshooting available at:

<https://fluence.science/products/wireless-flex-dimming/>, or contact Fluence Support.

5. COMMISSIONING APPS AND PRODUCT INFORMATION



WIRELESS FLEX DIMMING APPS:

Web App: <https://fluencewirelessflex.com>

First create an account, then download the mobile app.

Mobile App: iOS App Store (free download)

<https://apps.apple.com/us/app/fluence-wireless-flex/id1558821999>

Complete Product Information, Quick Start Guide, and Installation Videos: <https://fluence.science/products/wireless-flex-dimming/>

Support and Application Assistance: support@fluence-led.com

Telephone: (512) 212-4544

Support Hours: M – F 8:00 AM to 5:00 PM US Central Time

Mobile App



<https://apps.apple.com/us/app/fluence-wireless-flex/id1558821999>

6. SYSTEM DIAGRAM

SHYFT LIGHT SCHEDULER WITH WIRELESS FLEX DIMMING

1 ZONE

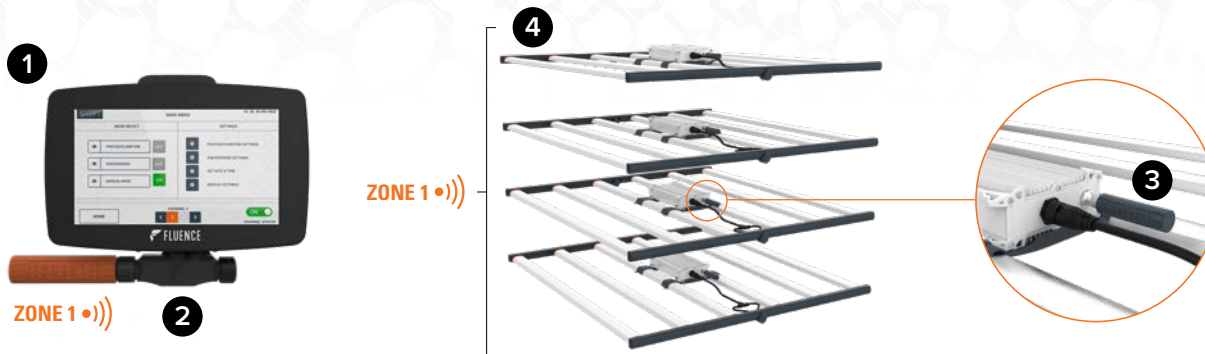

COMPONENTS

- 1 SHYFT Light Scheduler, sold separately (CTLA-SHYFT)
- 2 Wireless Flex Dimming 1 Zone Connectivity Kit for SHYFT Light Scheduler (WFDM-SHYFT-1ZONE)
- 3 Wireless Flex Dimming Receivers (1 required per power supply/light fixture, WFDM-10538-01)
- 4 Fluence Light Fixture, sold separately (SPYDR 2 shown)

2 ZONES

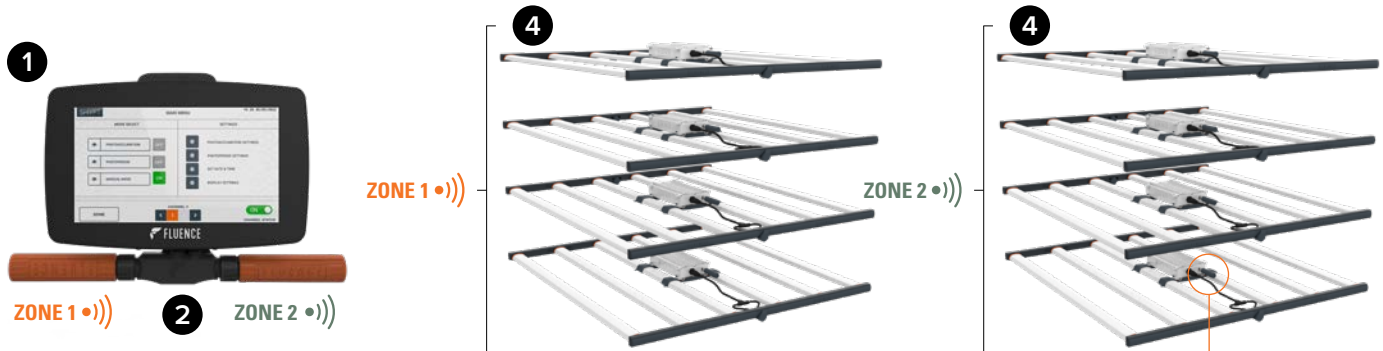

COMPONENTS

- 1 SHYFT Light Scheduler, sold separately (CTLA-SHYFT)
- 2 Wireless Flex Dimming 2 Zone Connectivity Kit for SHYFT Light Scheduler (WFDM-SHYFT-2ZONE)
- 3 Wireless Flex Dimming Receivers (1 required per power supply/light fixture, WFDM-10538-01)
- 4 Fluence Light Fixture, sold separately (SPYDR 2 shown)



7. CONTACT INFORMATION

Support & Business Development:

support@fluence-led.com

For More Information Visit:

<https://fluence.science/products/wireless-flex-dimming/>

Our Office Locations:

FLUENCE USA

4129 Commercial Center Drive

Suite 450

Austin, TX 78744

support@fluence-led.com



FLUENCE

Contact FLUENCE
support@fluence-led.com



www.fluence.science