

RAZR MODULAR SYSTEM WIRING GUIDE

THANK YOU FOR CHOOSING FLUENCE!

1. CAUTIONS AND WARNINGS	2
2. SYSTEM DC CABLE WIRING DIAGRAMS	3
3 and 6-Bar System Diagrams	3
4 and 8-Bar System Diagrams	10
3. RAZR MODULAR CABLES	15
DC Splitter Cables	15
DC Manifold Cables	16
DC Dimming Cables	17
AC Power Cables (Americas)	18
AC Power Cables (International)	19
4. POWER SUPPLY WIRING	20
5. PRODUCT GUARANTEE & WARRANTY	21



 VERTICAL LAYOUT

 HORIZONTAL LAYOUT

CAUTIONS AND WARNINGS

WARNING

Turn off and disconnect the power before installation. Installation should be performed by a qualified electrician in accordance with all national and local electrical and construction codes and regulations.

- DO NOT attempt to install or use this product until you have fully read and understand the installation instructions contained in the RAZR Modular wiring guide, the RAZR Modular user and installation guide, and on the product safety labels. Failure to follow the Fluence product instructions and safety label advice may result in damage to the product, damage to property, or personal injury. Be sure to retain a copy of this wiring guide and the user guide after installation for future reference.
- Risk of Electrical Shock. Turn off and disconnect the power before installing, moving, or cleaning to reduce the possibility of serious injury. DO NOT disconnect cables from the power supply or LED light bar while energized.
- Only connect the system to an electrical outlet or circuit of appropriate type and rating for the cord and plug. Connect the system only to power sources of the correct voltages and frequencies listed in the product specifications.
- Protect power cables from being pinched, walked on, or otherwise damaged.
- Use a strain-relief or power cord grip if needed. Maintain a minimum of 1" (2.5 cm) bend radius for all cables.
- Use IP wet-rated junction boxes and fittings for the power cords equal to the IP rating of the rating of the lighting system for the application.
- DO NOT connect to live power until installation is complete and all connections are made.
- DO NOT modify or alter the product; doing so will void the warranty. Please refer to the Fluence Terms and Conditions and Limited Warranty for further details.
- LED and heatsink surfaces may be hot. DO NOT touch while in operation. Allow sufficient cooling time before handling.
- To reduce the risk of overheating or fire, never place operating fixtures face down on a flush surface. Always allow for adequate ventilation of fixtures and power supplies.

CHEMICAL EXPOSURE PRECAUTION

Fluence lighting systems are designed to be resilient against crop protection products. Many chemicals used in the Commercial Horticultural Industry are corrosive to electronic equipment. If the luminaire is accidentally exposed to a corrosive liquid or vapor (e.g. VOC –Volatile Organic Compound and H₂S – Hydrogen Sulfide) the luminaire must be rinsed with clean water as soon as possible. The product warranty will no longer apply if the product is exposed or remains in the corrosive environment. It is recommended the luminaires be removed and protected from the corrosive environment during all periods of disinfection or sanitization of the facility.

CALIFORNIA PROPOSITION 65 WARNING

WARNING: This product contains chemicals known to the State of California to cause cancer and birth defects or other reproductive harm. For more information: www.P65Warnings.ca.gov.

PHOTOBIOLOGICAL HAZARD

Photobiological safety of lamps and lamp systems (IEC/EN 62471 and TR 62778). This International Standard describes the photobiological safety of lamps and lamp systems, including luminaires. The rating of this product according to this standard can be found in the table below.

Ordering Code	Radiation hazard - Retinal Blue Light 300-700 nm	Minimum viewing distance (meter/inch)	All Other Radiation Hazards
RM-xx-xx-DR9-xx	Risk Group 2 (Moderate)	2.6 / 102.36	Exempt Group (None)
All Others	Risk Group 1 (Low)	N/A	



Retinal Blue Light Radiation Hazard - RISK GROUP 2

CAUTION: POSSIBLY HAZARDOUS OPTICAL RADIATION EMITTED FROM THIS PRODUCT. DO NOT STARE AT THE OPERATING LAMP. MAY BE HARMFUL TO THE EYE.

These photobiological safety markings are based on testing of the light output characteristic of a single horticultural luminaire. Increased exposure risk to facility personnel may be present depending upon the number of horticultural luminaires and their placement and/or positioning within the plant growth facility.

It is the responsibility of the plant growth facility to address these risks at the facility level and to ensure that people entering the plant growth areas while the lights are on are aware of these risks and that appropriate safeguards are in place.

24-Bar RAZR Modular Systems

(8) 3-Bar Fixtures or (4) 6-Bar Fixtures

Fixture Array | Number of Fixtures per Power Supply

2'x4' 3-Bar	4'x4' 6-Bar
8 Fixtures	4 Fixtures

Installation	Pre-Configured Systems
Horizontal Array	RM-44SLBW3-3A8LV-S/ RM-44SLBW3-3A8HV-S RM-48SLBW3-3A8LV-S/ RM-48SLBW3-3A8HV-S RM-48SLBW4-3A8LV-S/ RM-48SLBW4-3A8HV-S
Vertical Array	RM-44SLBW3-3S8LV-S/ RM-44SLBW3-3S8HV-S RM-48SLBW3-3S8LV-S/ RM-48SLBW3-3S8HV-S RM-48SLBW4-3S8LV-S/ RM-48SLBW4-3S8HV-S



RAZR MODULAR COMPONENTS

Component RCC	Part Description	QTY per system	Ordering PN 12NC Single Pack (-S)	Ordering PN 12NC Bulk Pack (-B)	Bulk Pack Quantity	
A	RM-44-S-BW3	44" Light Bar, BROAD R3, uniform LED spacing	24	9124 017 02031	9124 017 02041	288
	RM-44-SL-BW3	44" Enclosed Light Bar, BROAD R3, uniform LED spacing	24	9124 017 02051	9124 017 02061	234
	RM-48-S-BW3	48" Light Bar, BROAD R3, uniform LED spacing	24	9124 017 02032	9124 017 02042	288
	RM-48-SL-BW3	48" Enclosed Light Bar, BROAD R3, uniform LED spacing	24	9124 017 02052	9124 017 02062	234
	RM-53-S-BW3	53" Light Bar, BROAD R3, uniform LED spacing	24	9124 017 02039	9124 017 02049	288
	RM-53-R-BW3	53" Light Bar, BROAD R3, redistributed LED spacing	24	9124 017 02040	9124 017 02050	288
	RM-53-SL-BW3	53" Enclosed Light Bar, BROAD R3, uniform LED spacing	24	9124 017 02059	9124 017 02069	234
	RM-53-RL-BW3	53" Enclosed Light Bar, BROAD R3, redistributed LED spacing	24	9124 017 02060	9124 017 02070	234
B	PLMG-V3A-600-111	Power supply, LVG,600W/11.1A,M19	1	9124 017 01914	9124 017 01988	24
	PHMG-V2C-600-111	Power supply, HVG,600W/11.1A,M19	1	9124 017 01910	9124 017 01984	33
	PHWG-V2C-600-111	Power supply, HVG,600W/11.1A,WLD	1	9124 017 02203	9124 017 02208	33
C	CDG-RMU23AFP6M1.2	3-Bar Right Angle DC Splitter, 4-FT Trunk	8	9124 017 02113	9124 017 02129	10
D	CDG-RMU24PPF9M1.4	4-port DC Manifold Cable, 4-FT Trunk	2	9124 017 02125	9124 017 02141	10
E	CDG-RMU2MSFP9M0.9	Manifold Splitter Cable, 3-FT to power supply	1	9124 017 02124	9124 017 02140	10
F	CDG-RMU23SFP6M1.2	3-Bar Straight DC Splitter, 4-FT Trunk	8	9124 017 02116	9124 017 02132	10
G	CDG-RMU28PPF9M0.9	8-port DC Manifold Cable, 2.25-FT Trunk	1	9124 017 02127	9124 017 02143	10
H	FF-RM-8S-2F	Fixture Frame Kit, 8" bar spacing, 2ft	8	9124 017 02102	N/A	N/A
I	FF-RM-8S-4F	Fixture Frame Kit, 8" bar spacing, 4ft	4	9124 017 02104	N/A	N/A

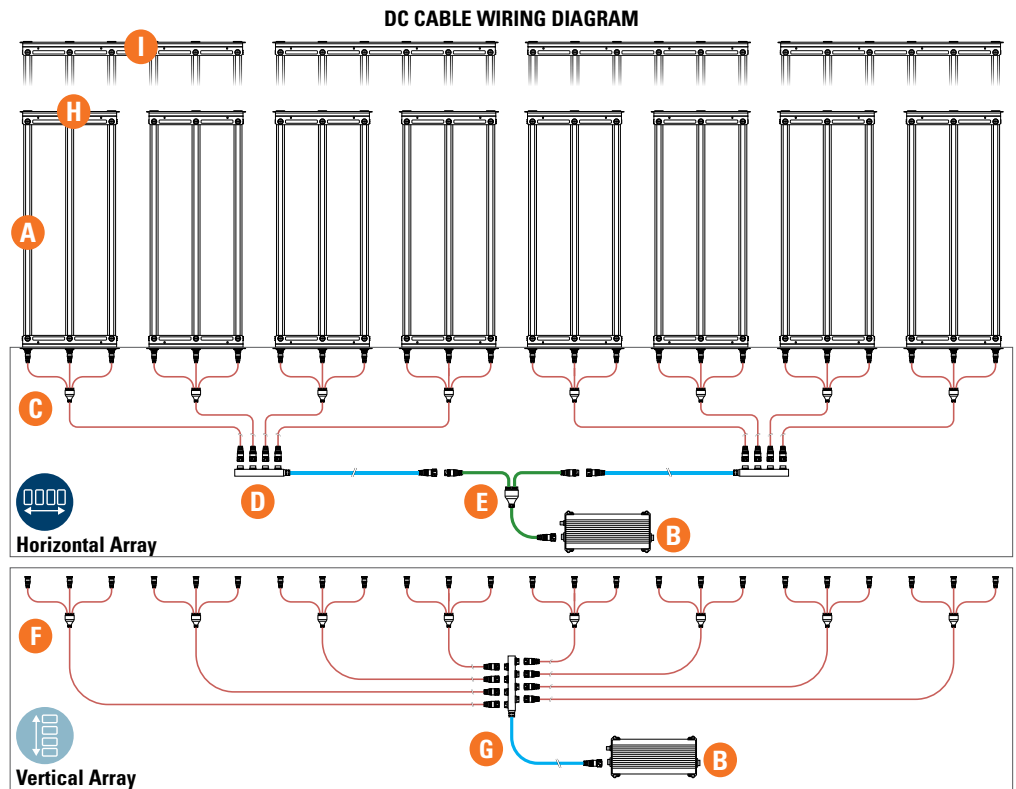
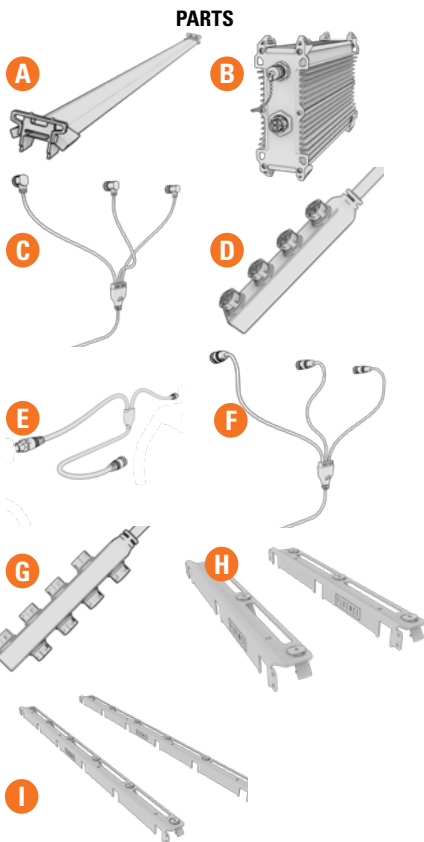

21-Bar RAZR Modular Systems

(7) 3-Bar Fixtures

Fixture Array | Number of Fixtures per Power Supply

2'x4' 3-Bar	
7 Fixtures	
Installation	Pre-Configured Systems
Horizontal Array	None
Vertical Array	None



RAZR MODULAR COMPONENTS

Component	RCC	Part Description	QTY per system	Ordering PN 12NC Single Pack (-S)	Ordering PN 12NC Bulk Pack (-B)	Bulk Pack Quantity
A	RM-44-S-BW3	44" Light Bar, BROAD R3, uniform LED spacing	21	9124 017 02031	9124 017 02041	288
	RM-44-SL-BW3	44" Enclosed Light Bar, BROAD R3, uniform LED spacing	21	9124 017 02051	9124 017 02061	234
	RM-48-S-BW3	48" Light Bar, BROAD R3, uniform LED spacing	21	9124 017 02032	9124 017 02042	288
	RM-48-SL-BW3	48" Enclosed Light Bar, BROAD R3, uniform LED spacing	21	9124 017 02052	9124 017 02062	234
	RM-53-S-BW3	53" Light Bar, BROAD R3, uniform LED spacing	21	9124 017 02039	9124 017 02049	288
	RM-53-R-BW3	53" Light Bar, BROAD R3, redistributed LED spacing	21	9124 017 02040	9124 017 02050	288
	RM-53-SL-BW3	53" Enclosed Light Bar, BROAD R3, uniform LED spacing	21	9124 017 02059	9124 017 02069	234
	RM-53-RL-BW3	53" Enclosed Light Bar, BROAD R3, redistributed LED spacing	21	9124 017 02060	9124 017 02070	234
B	PLMG-V3A-600-097	Power supply, LVG,600W/9.7A,M19	1	9124 017 02013	9124 017 02014	24
	PHMG-V2C-600-097	Power supply, PHV,600W/9.7A,M19	1	9124 017 02017	9124 017 02018	33
	PHWG-V2C-600-097	Power supply, HVG,600W/9.7A,WLD	1	9124 017 02204	9124 017 02209	33
C	CDG-RMU23AFP6M1.2	3-Bar Right Angle DC Splitter, 4-FT Trunk	7	9124 017 02113	9124 017 02129	10
D	CDG-RMU24FP9M1.4	4-port DC Manifold Cable, 4-FT Trunk	2	9124 017 02125	9124 017 02141	10
E	CDG-RMU2MSFP9M0.9	Manifold Splitter Cable, 3-FT to power supply	1	9124 017 02124	9124 017 02140	10
F	RM-MDC	Manifold Port Dust Cap (covering unused ports)	1	9124 017 02328	9124 017 02329	100
G	CDG-RMU23SFP6M1.2	3-Bar Straight DC Splitter, 4-FT Trunk	8	9124 017 02116	9124 017 02132	10
H	CDG-RMU28FP9M0.9	8-port DC Manifold Cable, 2.25-FT Trunk	1	9124 017 02127	9124 017 02143	10
I	FF-RM-8S-2F	Fixture Frame Kit, 8" bar spacing, 2ft	7	9124 017 02102	N/A	N/A

PARTS

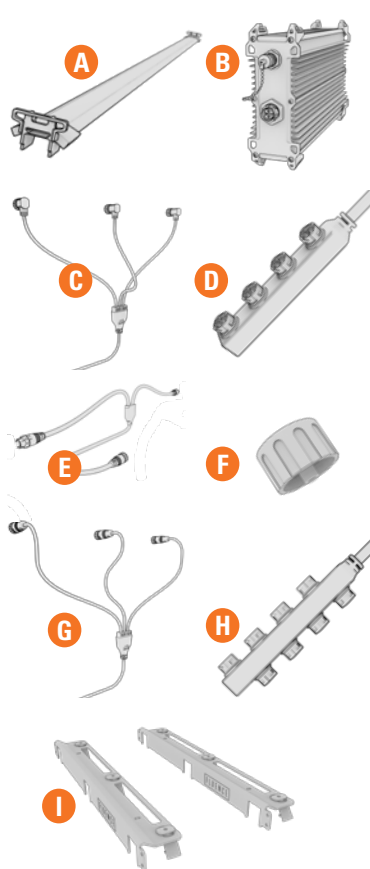

DC CABLE WIRING DIAGRAM

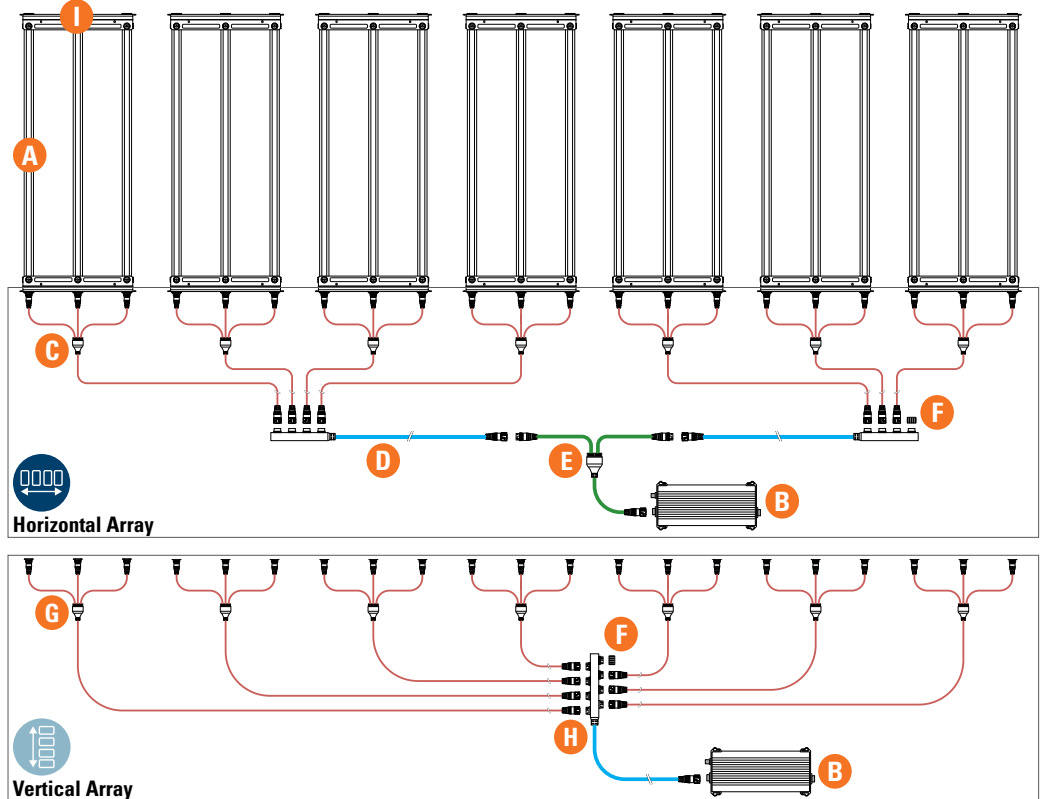

18-Bar RAZR Modular Systems

(6) 3-Bar Fixtures or (3) 6-Bar Fixtures

Fixture Array | Number of Fixtures per Power Supply

2'x4' 3-Bar	4'x4' 6-Bar
6 Fixtures	3 Fixtures
Installation	Pre-Configured Systems
Horizontal Array	RM-44SLBW3-3A6LV-S/ RM-44SLBW3-3A6HV-S RM-48SLBW3-3A6LV-S/ RM-48SLBW3-3A6HV-S RM-48SLBW4-3A6LV-S/ RM-48SLBW4-3A6HV-S
Vertical Array	RM-44SLBW3-3S6LV-S/ RM-44SLBW3-3S6HV-S RM-48SLBW3-3S6LV-S/ RM-48SLBW3-3S6HV-S RM-48SLBW4-3S6LV-S/ RM-48SLBW4-3S6HV-S



RAZR MODULAR COMPONENTS

Component	RCC	Part Description	QTY per system	Ordering PN 12NC Single Pack (-S)	Ordering PN 12NC Bulk Pack (-B)	Bulk Pack Quantity
A	RM-44-S-BW3	44" Light Bar, BROAD R3, uniform LED spacing	18	9124 017 02031	9124 017 02041	288
	RM-44-SL-BW3	44" Enclosed Light Bar, BROAD R3, uniform LED spacing	18	9124 017 02051	9124 017 02061	234
	RM-48-S-BW3	48" Light Bar, BROAD R3, uniform LED spacing	18	9124 017 02032	9124 017 02042	288
	RM-48-SL-BW3	48" Enclosed Light Bar, BROAD R3, uniform LED spacing	18	9124 017 02052	9124 017 02062	234
	RM-53-S-BW3	53" Light Bar, BROAD R3, uniform LED spacing	18	9124 017 02039	9124 017 02049	288
	RM-53-R-BW3	53" Light Bar, BROAD R3, redistributed LED spacing	18	9124 017 02040	9124 017 02050	288
	RM-53-SL-BW3	53" Enclosed Light Bar, BROAD R3, uniform LED spacing	18	9124 017 02059	9124 017 02069	234
	RM-53-RL-BW3	53" Enclosed Light Bar, BROAD R3, redistributed LED spacing	18	9124 017 02060	9124 017 02070	234
B	PLMG-V3A-600-083	Power supply, LVG,600W/8.3A,M19	1	9124 017 02015	9124 017 02016	24
	PHMG-V2C-600-083	Power supply, HVG,600W/8.3A,M19	1	9124 017 01911	9124 017 01985	33
	PHWG-V2C-600-083	Power supply, HVG,600W/8.3A,WLD	1	9124 017 02206	9124 017 02211	33
C	CDG-RMU23AFP6M1.2	3-Bar Right Angle DC Splitter, 4-FT Trunk	6	9124 017 02113	9124 017 02129	10
D	CDG-RMU24PPF9M1.4	4-port DC Manifold Cable, 4-FT Trunk	2	9124 017 02125	9124 017 02141	10
E	CDG-RMU2MSFP9M0.9	Manifold Splitter Cable, 3-FT to power supply	1	9124 017 02124	9124 017 02140	10
F	RM-MDC	Manifold Port Dust Cap (covering unused ports)	2	9124 017 02328	9124 017 02329	100
G	CDG-RMU23SFP6M1.2	3-Bar Straight DC Splitter, 4-FT Trunk	6	9124 017 02116	9124 017 02132	10
H	CDG-RMU26PPF9M1.5	6-port DC Manifold Cable, 4-FT Trunk	1	9124 017 02126	9124 017 02142	10
I	FF-RM-8S-2F	Fixture Frame Kit, 8" bar spacing, 2ft	7	9124 017 02102	N/A	N/A
J	FF-RM-8S-4F	Fixture Frame Kit, 8" bar spacing, 4ft	4	9124 017 02104	N/A	N/A

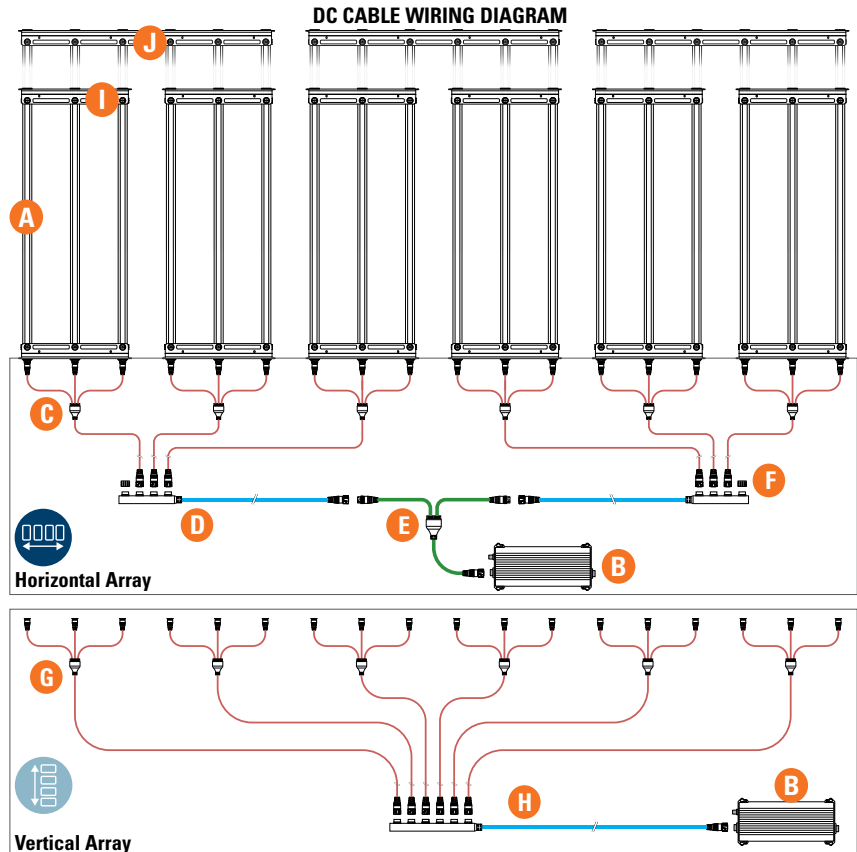
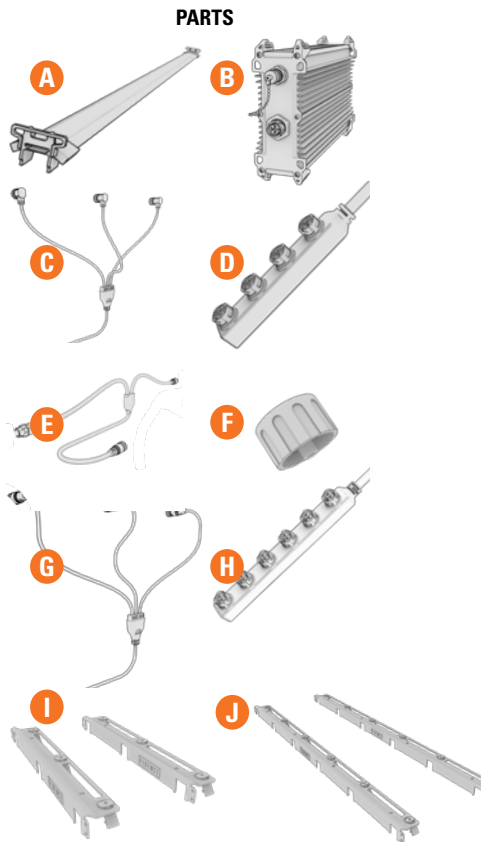

15-Bar RAZR Modular Systems

(5) 3-Bar Fixtures

Fixture Array | Number of Fixtures per Power Supply

2'x4' 3-Bar	
5 Fixtures	
Installation	Pre-Configured Systems
Horizontal Array	None
Vertical Array	None



RAZR MODULAR COMPONENTS

Component	RCC	Part Description	QTY per system	Ordering PN 12NC Single Pack (-S)	Ordering PN 12NC Bulk Pack (-B)	Bulk Pack Quantity
A	RM-44-S-BW3	44" Light Bar, BROAD R3, uniform LED spacing	15	9124 017 02031	9124 017 02041	288
	RM-44-SL-BW3	44" Enclosed Light Bar, BROAD R3, uniform LED spacing	15	9124 017 02051	9124 017 02061	234
	RM-48-S-BW3	48" Light Bar, BROAD R3, uniform LED spacing	15	9124 017 02032	9124 017 02042	288
	RM-48-SL-BW3	48" Enclosed Light Bar, BROAD R3, uniform LED spacing	15	9124 017 02052	9124 017 02062	234
	RM-53-S-BW3	53" Light Bar, BROAD R3, uniform LED spacing	15	9124 017 02039	9124 017 02049	288
	RM-53-R-BW3	53" Light Bar, BROAD R3, redistributed LED spacing	15	9124 017 02040	9124 017 02050	288
	RM-53-SL-BW3	53" Enclosed Light Bar, BROAD R3, uniform LED spacing	15	9124 017 02059	9124 017 02069	234
	RM-53-RL-BW3	53" Enclosed Light Bar, BROAD R3, redistributed LED spacing	15	9124 017 02060	9124 017 02070	234
B	PLMG-V3A-600-069	Power supply, LVG,600W/6.9A,M19	1	9124 017 01916	9124 017 01990	24
	PHMG-V2C-600-069	Power supply, HVG,600W/6.9A,M19	1	9124 017 01913	9124 017 01987	33
	PHWG-V2C-600-069	Power supply, HVG,600W/6.9A,WLD	1	9124 017 02207	9124 017 02212	33
C	CDG-RMU23AFP6M1.2	3-Bar Right Angle DC Splitter, 4-FT Trunk	5	9124 017 02113	9124 017 02129	10
D	CDG-RMU24PFP9M1.4	4-port DC Manifold Cable, 4-FT Trunk	2	9124 017 02125	9124 017 02141	10
E	CDG-RMU2MSFP9M0.9	Manifold Splitter Cable, 3-FT to power supply	1	9124 017 02124	9124 017 02140	10
F	RM-MDC	Manifold Port Dust Cap (covering unused ports)	3	9124 017 02328	9124 017 02329	100
G	CDG-RMU23SFP6M1.2	3-Bar Straight DC Splitter, 4-FT Trunk	5	9124 017 02116	9124 017 02132	10
H	CDG-RMU26PFP9M1.5	6-port DC Manifold Cable, 4-FT Trunk	1	9124 017 02126	9124 017 02142	10
I	FF-RM-8S-2F	Fixture Frame Kit, 8" bar spacing, 2ft	5	9124 017 02102	N/A	N/A

PARTS

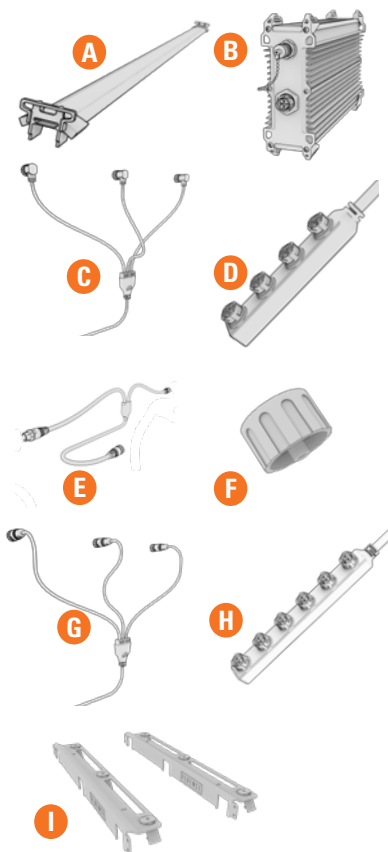

DC CABLE WIRING DIAGRAM

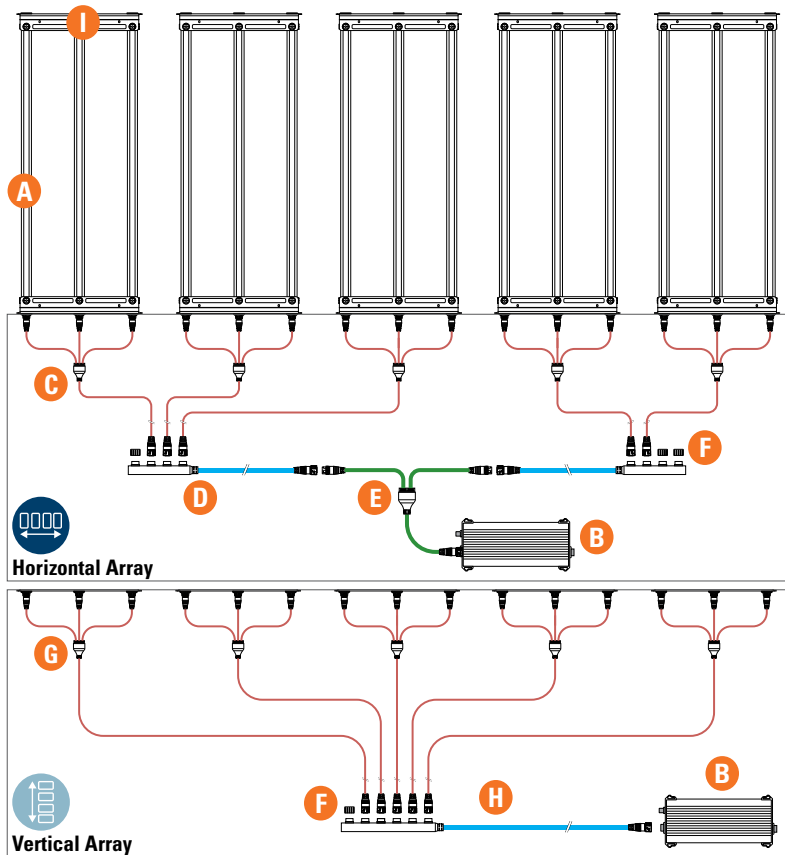

12-Bar RAZR Modular Systems

(4) 3-Bar Fixtures or (2) 6-Bar Fixtures

Fixture Array | Number of Fixtures per Power Supply

	2'x4' 3-Bar	4'x4' 6-Bar
	4 Fixtures	2 Fixtures
Installation	Pre-Configured Systems	
Horizontal Array	RM-44SLBW3-3A4LV-S/ RM-44SLBW3-3A4HV-S RM-48SLBW3-3A4LV-S/ RM-48SLBW3-3A4HV-S RM-48SLBW4-3A4LV-S/ RM-48SLBW4-3A4HV-S	
Vertical Array	RM-44SLBW3-3S4LV-S/ RM-44SLBW3-3S4HV-S RM-48SLBW3-3S4LV-S/ RM-48SLBW3-3S4HV-S RM-48SLBW4-3S4LV-S/ RM-48SLBW4-3S4HV-S	



RAZR MODULAR COMPONENTS

Component	RCC	Part Description	QTY per system	Ordering PN 12NC Single Pack (-S)	Ordering PN 12NC Bulk Pack (-B)	Bulk Pack Quantity
A	RM-44-S-BW3	44" Light Bar, BROAD R3, uniform LED spacing	12	9124 017 02031	9124 017 02041	288
	RM-44-SL-BW3	44" Enclosed Light Bar, BROAD R3, uniform LED spacing	12	9124 017 02051	9124 017 02061	234
	RM-48-S-BW3	48" Light Bar, BROAD R3, uniform LED spacing	12	9124 017 02032	9124 017 02042	288
	RM-48-SL-BW3	48" Enclosed Light Bar, BROAD R3, uniform LED spacing	12	9124 017 02052	9124 017 02062	234
	RM-53-S-BW3	53" Light Bar, BROAD R3, uniform LED spacing	12	9124 017 02039	9124 017 02049	288
	RM-53-R-BW3	53" Light Bar, BROAD R3, redistributed LED spacing	12	9124 017 02040	9124 017 02050	288
	RM-53-SL-BW3	53" Enclosed Light Bar, BROAD R3, uniform LED spacing	12	9124 017 02059	9124 017 02069	234
	RM-53-RL-BW3	53" Enclosed Light Bar, BROAD R3, redistributed LED spacing	12	9124 017 02060	9124 017 02070	234
B	PLMG-V3B-320-056	Power supply, LVG,320W/5.6A,M19	1	9124 017 02021	9124 017 02022	30
	PHMG-V3B-320-056	Power supply, HVG,320W/5.6A,M19	1	9124 017 01909	9124 017 01983	30
C	CDG-RMU23AFP6M1.2	3-Bar Right Angle DC Splitter, 4-FT Trunk	4	9124 017 02113	9124 017 02129	10
D	CDG-RMU24PP9M1.4	4-port DC Manifold Cable, 4-FT Trunk	1	9124 017 02125	9124 017 02141	10
E	CDG-RMU23SFP6M1.2	3-Bar Straight DC Splitter, 4-FT Trunk	4	9124 017 02116	9124 017 02132	10
F	FF-RM-8S-2F	Fixture Frame Kit, 8" bar spacing, 2ft	4	9124 017 02102	N/A	N/A
G	FF-RM-8S-4F	Fixture Frame Kit, 8" bar spacing, 4ft	2	9124 017 02104	N/A	N/A

PARTS

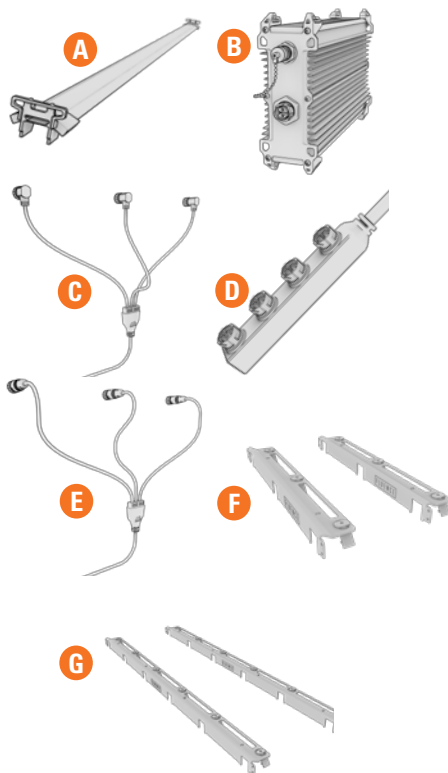

DC CABLE WIRING DIAGRAM

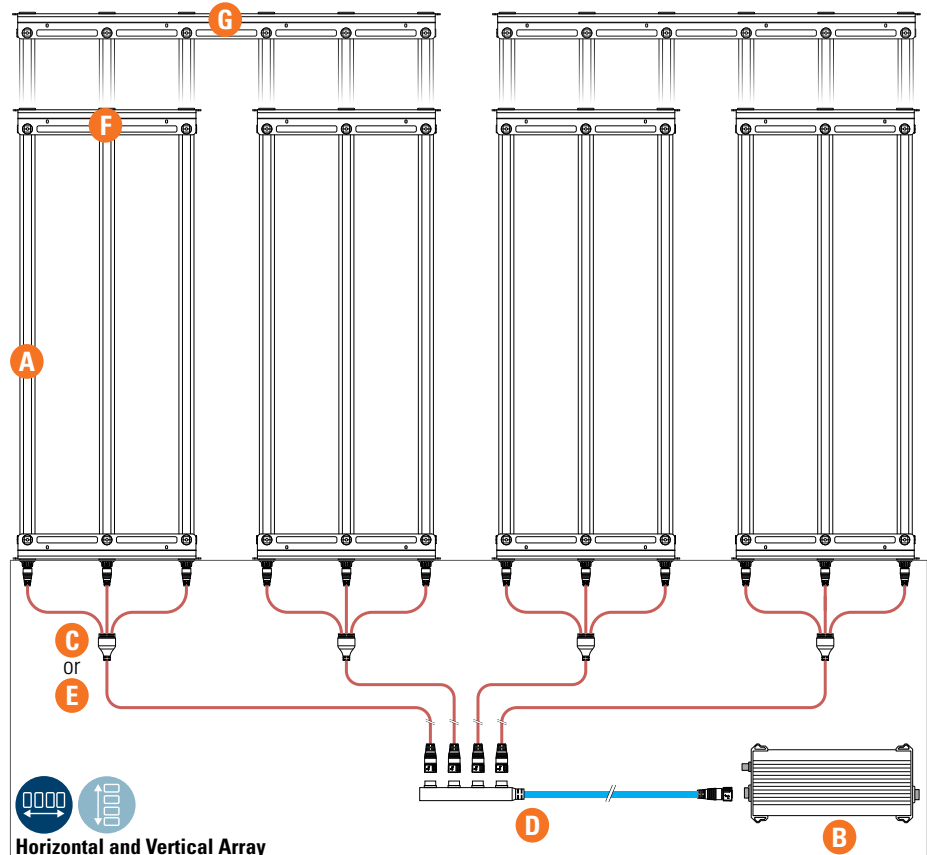

9-Bar RAZR Modular Systems

(3) 3-Bar Fixtures

Fixture Array | Number of Fixtures per Power Supply

2'x4' 3-Bar	
3 Fixtures	
Installation	Pre-Configured Systems
Horizontal Array	RM-44SLBW3-3A3LV-S/ RM-44SLBW3-3A3HV-S RM-48SLBW3-3A3LV-S/ RM-48SLBW3-3A3HV-S RM-48SLBW4-3A4LV-S/ RM-48SLBW4-3A3HV-S
Vertical Array	RM-44SLBW3-3S3LV-S/ RM-44SLBW3-3S3HV-S RM-48SLBW3-3S3LV-S/ RM-48SLBW3-3S3HV-S RM-48SLBW4-3S3LV-S/ RM-48SLBW4-3S3HV-S



RAZR MODULAR COMPONENTS

Component	RCC	Part Description	QTY per system	Ordering PN 12NC Single Pack (-S)	Ordering PN 12NC Bulk Pack (-B)	Bulk Pack Quantity
A	RM-44-S-BW3	44" Light Bar, BROAD R3, uniform LED spacing	9	9124 017 02031	9124 017 02041	288
	RM-44-SL-BW3	44" Enclosed Light Bar, BROAD R3, uniform LED spacing	9	9124 017 02051	9124 017 02061	234
	RM-48-S-BW3	48" Light Bar, BROAD R3, uniform LED spacing	9	9124 017 02032	9124 017 02042	288
	RM-48-SL-BW3	48" Enclosed Light Bar, BROAD R3, uniform LED spacing	9	9124 017 02052	9124 017 02062	234
	RM-53-S-BW3	53" Light Bar, BROAD R3, uniform LED spacing	9	9124 017 02039	9124 017 02049	288
	RM-53-R-BW3	53" Light Bar, BROAD R3, redistributed LED spacing	9	9124 017 02040	9124 017 02050	288
	RM-53-SL-BW3	53" Enclosed Light Bar, BROAD R3, uniform LED spacing	9	9124 017 02059	9124 017 02069	234
	RM-53-RL-BW3	53" Enclosed Light Bar, BROAD R3, redistributed LED spacing	9	9124 017 02060	9124 017 02070	234
B	PLMG-V3B-320-042	Power supply, LVG,320W/4.2A,M19	1	9124 017 02023	9124 017 02024	30
	PHMG-V3B-320-042	Power supply, HVG,320W/4.2A,M19	1	9124 017 02026	9124 017 02025	30
C	CDG-RMU23AFP6M1.2	3-Bar Right Angle DC Splitter, 4-FT Trunk	3	9124 017 02113	9124 017 02129	10
D	CDG-RMU24PFP9M1.4	4-port DC Manifold Cable, 4-FT Trunk	1	9124 017 02125	9124 017 02141	10
E	RM-MDC	Manifold Port Dust Cap (covering unused ports)	1	9124 017 02328	9124 017 02329	100
F	CDG-RMU23SFP6M1.2	3-Bar Straight DC Splitter, 4-FT Trunk	3	9124 017 02116	9124 017 02132	10
G	FF-RM-8S-2F	Fixture Frame Kit, 8" bar spacing, 2ft	3	9124 017 02102	N/A	N/A

PARTS

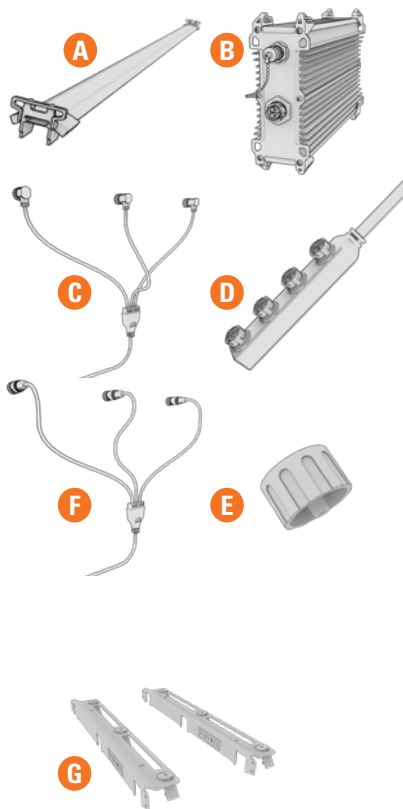

DC CABLE WIRING DIAGRAM

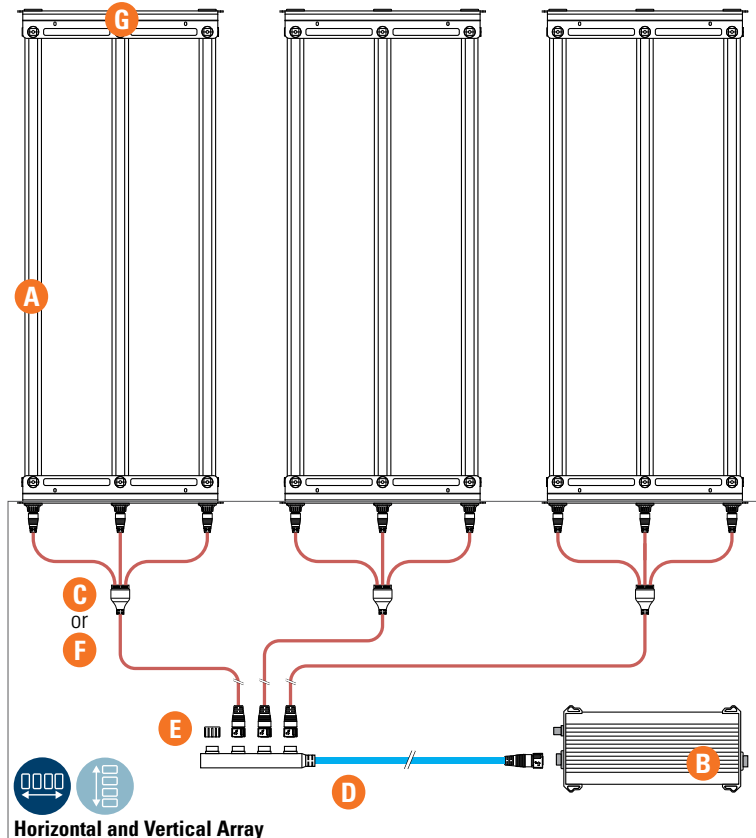

6-Bar RAZR Modular Systems

(2) 3-Bar Fixtures or (1) 6-Bar Fixtures

Fixture Array | Number of Fixtures per Power Supply

2'x4' 3-Bar	4'x4' 6-Bar
2 Fixtures	1 Fixture
Installation	
Pre-Configured Systems	
Horizontal Array	None
Vertical Array	None



RAZR MODULAR COMPONENTS

Component	RCC	Part Description	QTY per system	Ordering PN 12NC Single Pack (-S)	Ordering PN 12NC Bulk Pack (-B)	Bulk Pack Quantity
A	RM-44-S-BW3	44" Light Bar, BROAD R3, uniform LED spacing	6	9124 017 02031	9124 017 02041	288
	RM-44-SL-BW3	44" Enclosed Light Bar, BROAD R3, uniform LED spacing	6	9124 017 02051	9124 017 02061	234
	RM-48-S-BW3	48" Light Bar, BROAD R3, uniform LED spacing	6	9124 017 02032	9124 017 02042	288
	RM-48-SL-BW3	48" Enclosed Light Bar, BROAD R3, uniform LED spacing	6	9124 017 02052	9124 017 02062	234
	RM-53-S-BW3	53" Light Bar, BROAD R3, uniform LED spacing	6	9124 017 02039	9124 017 02049	288
	RM-53-R-BW3	53" Light Bar, BROAD R3, redistributed LED spacing	6	9124 017 02040	9124 017 02050	288
	RM-53-SL-BW3	53" Enclosed Light Bar, BROAD R3, uniform LED spacing	6	9124 017 02059	9124 017 02069	234
	RM-53-RL-BW3	53" Enclosed Light Bar, BROAD R3, redistributed LED spacing	6	9124 017 02060	9124 017 02070	234
B	PLMG-V3B-320-028	Power supply, LVG,320W/2.8A,M19	1	9124 017 01918	9124 017 01992	30
	PHMG-V3B-320-028	Power supply, HVG,320W/2.8A,M19	1	9124 017 02030	9124 017 02029	30
C	CDG-RMU23AFP6M1.2	3-Bar Right Angle DC Splitter, 4-FT Trunk	2	9124 017 02113	9124 017 02129	10
D	CDG-RMU24PPF9M1.4	4-port DC Manifold Cable, 4-FT Trunk	1	9124 017 02125	9124 017 02141	10
E	RM-MDC	Manifold Port Dust Cap (covering unused ports)	2	9124 017 02328	9124 017 02329	100
F	CDG-RMU23SFP6M1.2	3-Bar Straight DC Splitter, 4-FT Trunk	2	9124 017 02116	9124 017 02132	10
G	FF-RM-8S-2F	Fixture Frame Kit, 8" bar spacing, 2ft	2	9124 017 02102	N/A	N/A
H	FF-RM-8S-4F	Fixture Frame Kit, 8" bar spacing, 4ft	1	9124 017 02104	N/A	N/A

PARTS

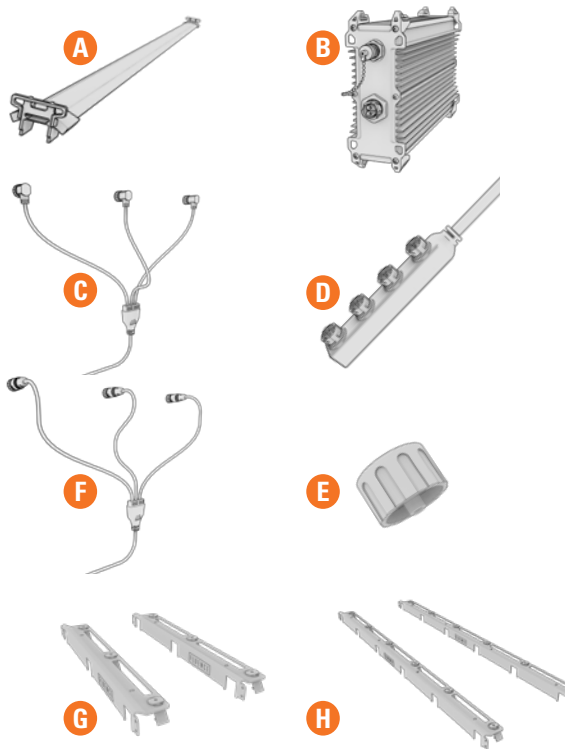

DC CABLE WIRING DIAGRAM

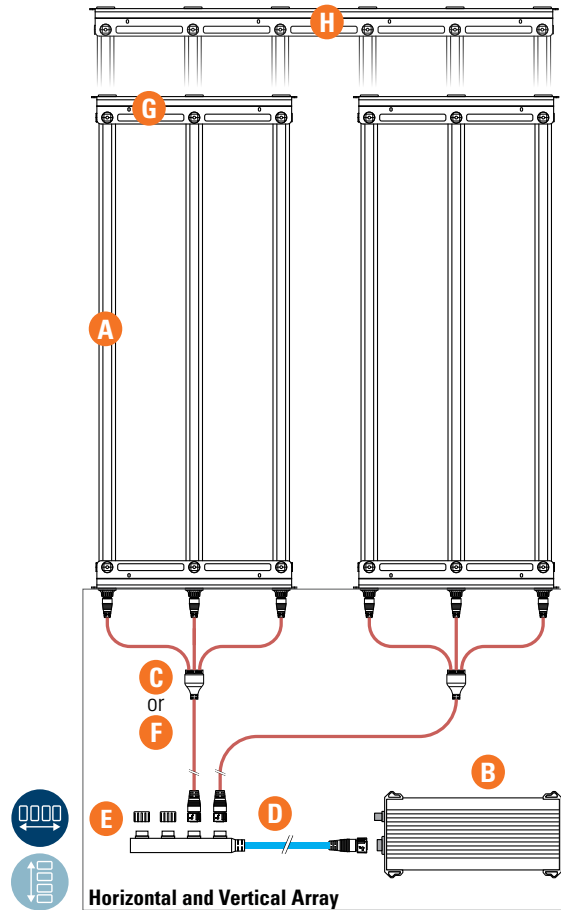

24-Bar RAZR Modular Systems

(6) 4-Bar Fixtures or (3) 8-Bar Fixtures

Fixture Array | Number of Fixtures per Power Supply

	2'x4' 4-Bar	4'x4' 8-Bar
	6 Fixtures	3 Fixtures
Installation	Pre-Configured Systems	
Horizontal Array	RM-44SLBW3-3A8LV-S/ RM-44SLBW3-3A8HV-S RM-48SLBW3-3A8LV-S/ RM-48SLBW3-3A8HV-S RM-48SLBW4-3A8LV-S/ RM-48SLBW4-3A8HV-S	
Vertical Array	RM-44SLBW3-3S8LV-S/ RM-44SLBW3-3S8HV-S RM-48SLBW3-3S8LV-S/ RM-48SLBW3-3S8HV-S RM-48SLBW4-3S8LV-S/ RM-48SLBW4-3S8HV-S	



RAZR MODULAR COMPONENTS

Component	RCC	Part Description	QTY per system	Ordering PN 12NC Single Pack (-S)	Ordering PN 12NC Bulk Pack (-B)	Bulk Pack Quantity
A	RM-44-S-BW3	44" Light Bar, BROAD R3, uniform LED spacing	24	9124 017 02031	9124 017 02041	288
	RM-44-SL-BW3	44" Enclosed Light Bar, BROAD R3, uniform LED spacing	24	9124 017 02051	9124 017 02061	234
	RM-48-S-BW3	48" Light Bar, BROAD R3, uniform LED spacing	24	9124 017 02032	9124 017 02042	288
	RM-48-SL-BW3	48" Enclosed Light Bar, BROAD R3, uniform LED spacing	24	9124 017 02052	9124 017 02062	234
	RM-53-S-BW3	53" Light Bar, BROAD R3, uniform LED spacing	24	9124 017 02039	9124 017 02049	288
	RM-53-R-BW3	53" Light Bar, BROAD R3, redistributed LED spacing	24	9124 017 02040	9124 017 02050	288
	RM-53-SL-BW3	53" Enclosed Light Bar, BROAD R3, uniform LED spacing	24	9124 017 02059	9124 017 02069	234
	RM-53-RL-BW3	53" Enclosed Light Bar, BROAD R3, redistributed LED spacing	24	9124 017 02060	9124 017 02070	234
B	PLMG-V3A-600-111	Power supply, LVG,600W/11.1A,M19	1	9124 017 01914	9124 017 01988	24
	PHMG-V2C-600-111	Power supply, HVG,600W/11.1A,M19	1	9124 017 01910	9124 017 01984	33
	PHWG-V2C-600-111	Power supply, HVG,600W/11.1A,WLD	1	9124 017 02203	9124 017 02208	33
C	CDG-RMU24AFP6M1.2	4-Bar Right Angle DC Splitter, 4-FT Trunk	6	9124 017 02114	9124 017 02130	10
D	CDG-RMU24PP9M1.4	4-port DC Manifold Cable, 4-FT Trunk	2	9124 017 02125	9124 017 02141	10
E	CDG-RMU2MSFP9M0.9	Manifold Splitter Cable, 3-FT to power supply	1	9124 017 02124	9124 017 02140	10
F	RM-MDC	Manifold Port Dust Cap (covering unused ports)	2	9124 017 02328	9124 017 02329	100
G	CDG-RMU24SFP6M1.2	4-Bar Straight DC Splitter, 4-FT Trunk	6	9124 017 02117	9124 017 02133	10
H	CDG-RMU26PP9M1.5	6-port DC Manifold Cable, 4-FT Trunk	1	9124 017 02126	9124 017 02142	10
I	FF-RM-6S-2F	Fixture Frame Kit, 6" bar spacing, 2ft	6	9124 017 02103	N/A	N/A
J	FF-RM-6S-4F	Fixture Frame Kit, 6" bar spacing, 4ft	3	9124 017 02105	N/A	N/A

PARTS

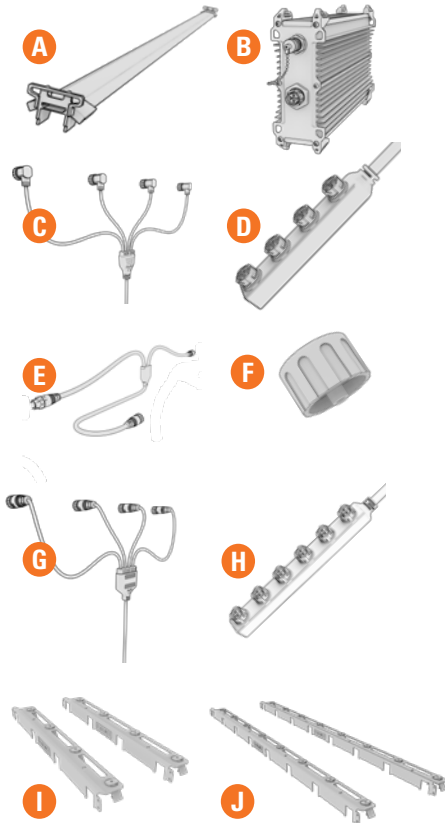

DC CABLE WIRING DIAGRAM

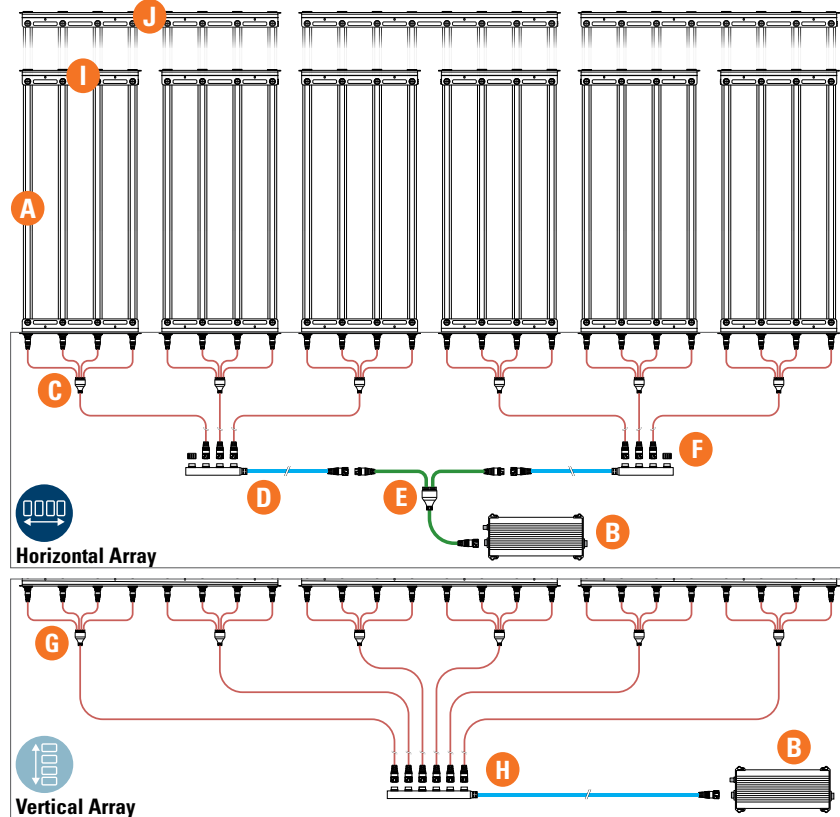

20-Bar RAZR Modular Systems

(5) 4-Bar Fixtures

Fixture Array | Number of Fixtures per Power Supply

2'x4' 4-Bar	
5 Fixtures	
Installation	Pre-Configured Systems
Horizontal Array	None
Vertical Array	None



RAZR MODULAR COMPONENTS

Component	RCC	Part Description	QTY per system	Ordering PN 12NC Single Pack (-S)	Ordering PN 12NC Bulk Pack (-B)	Bulk Pack Quantity
A	RM-44-S-BW3	44" Light Bar, BROAD R3, uniform LED spacing	20	9124 017 02031	9124 017 02041	288
	RM-44-SL-BW3	44" Enclosed Light Bar, BROAD R3, uniform LED spacing	20	9124 017 02051	9124 017 02061	234
	RM-48-S-BW3	48" Light Bar, BROAD R3, uniform LED spacing	20	9124 017 02032	9124 017 02042	288
	RM-48-SL-BW3	48" Enclosed Light Bar, BROAD R3, uniform LED spacing	20	9124 017 02052	9124 017 02062	234
	RM-53-S-BW3	53" Light Bar, BROAD R3, uniform LED spacing	20	9124 017 02039	9124 017 02049	288
	RM-53-R-BW3	53" Light Bar, BROAD R3, redistributed LED spacing	20	9124 017 02040	9124 017 02050	288
	RM-53-SL-BW3	53" Enclosed Light Bar, BROAD R3, uniform LED spacing	20	9124 017 02059	9124 017 02069	234
	RM-53-RL-BW3	53" Enclosed Light Bar, BROAD R3, redistributed LED spacing	20	9124 017 02060	9124 017 02070	234
B	PLMG-V3A-600-093	Power supply, LVG,600W/9.3A,M19	1	9124 017 02013	9124 017 02014	24
	PHMG-V2C-600-093	Power supply, PHV,600W/9.3A,M19	1	9124 017 02017	9124 017 02018	33
	PHWG-V2C-600-093	Power supply, HVG,600W/9.3A,WLD	1	9124 017 02204	9124 017 02209	33
C	CDG-RMU24AFP6M1.2	4-Bar Right Angle DC Splitter, 4-FT Trunk	5	9124 017 02114	9124 017 02130	10
D	CDG-RMU26PFP9M1.5	6-port DC Manifold Cable, 4-FT Trunk	1	9124 017 02126	9124 017 02142	10
E	RM-MDC	Manifold Port Dust Cap (covering unused ports)	1	9124 017 02328	9124 017 02329	100
F	CDG-RMU24SFP6M1.2	4-Bar Straight DC Splitter, 4-FT Trunk	5	9124 017 02117	9124 017 02133	10
G	FF-RM-6S-2F	Fixture Frame Kit, 6" bar spacing, 2ft	5	9124 017 02103	N/A	N/A

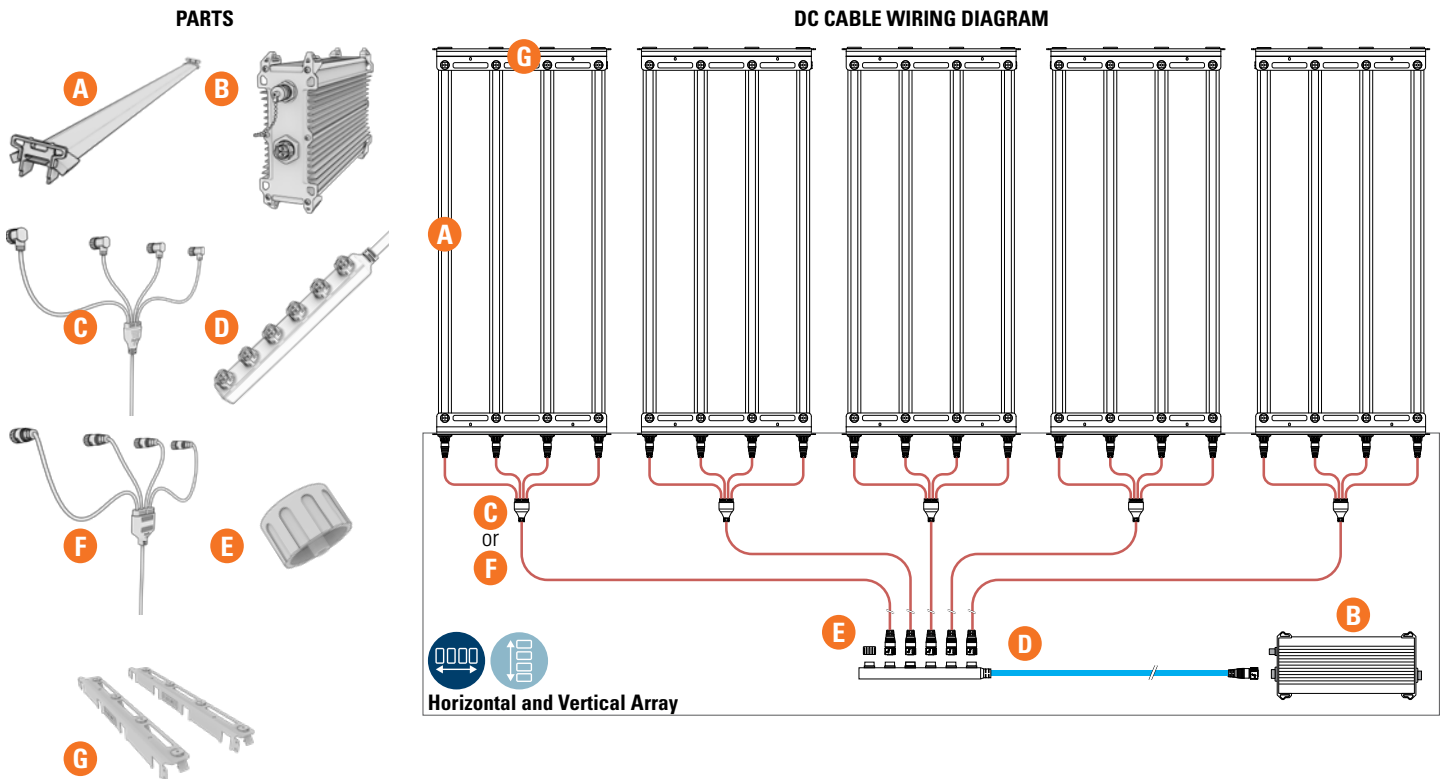

16-Bar RAZR Modular Systems

(4) 4-Bar Fixtures or (2) 8-Bar Fixtures

Fixture Array | Number of Fixtures per Power Supply

2'x4' 4-Bar	4'x4' 8-Bar
4 Fixtures	2 Fixtures
Installation	Pre-Configured Systems
Horizontal Array	RM-44SLBW3-4A4LV-S/ RM-44SLBW3-4A4HV-S RM-48SLBW3-4A4LV-S/ RM-48SLBW3-4A4HV-S RM-48SLBW4-4A4LV-S/ RM-48SLBW4-4A4HV-S
Vertical Array	RM-44SLBW3-4S4LV-S/ RM-44SLBW3-4S4HV-S RM-48SLBW3-4S4LV-S/ RM-48SLBW3-4S4HV-S RM-48SLBW4-4S4LV-S/ RM-48SLBW4-4S4HV-S



RAZR MODULAR COMPONENTS

Component	RCC	Part Description	QTY per system	Ordering PN 12NC Single Pack (-S)	Ordering PN 12NC Bulk Pack (-B)	Bulk Pack Quantity
A	RM-44-S-BW3	44" Light Bar, BROAD R3, uniform LED spacing	16	9124 017 02031	9124 017 02041	288
	RM-44-SL-BW3	44" Enclosed Light Bar, BROAD R3, uniform LED spacing	16	9124 017 02051	9124 017 02061	234
	RM-48-S-BW3	48" Light Bar, BROAD R3, uniform LED spacing	16	9124 017 02032	9124 017 02042	288
	RM-48-SL-BW3	48" Enclosed Light Bar, BROAD R3, uniform LED spacing	16	9124 017 02052	9124 017 02062	234
	RM-53-S-BW3	53" Light Bar, BROAD R3, uniform LED spacing	16	9124 017 02039	9124 017 02049	288
	RM-53-R-BW3	53" Light Bar, BROAD R3, redistributed LED spacing	16	9124 017 02040	9124 017 02050	288
	RM-53-SL-BW3	53" Enclosed Light Bar, BROAD R3, uniform LED spacing	16	9124 017 02059	9124 017 02069	234
	RM-53-RL-BW3	53" Enclosed Light Bar, BROAD R3, redistributed LED spacing	16	9124 017 02060	9124 017 02070	234
B	PLMG-V3A-600-074	Power supply, LVG,600W/7.4A,M19	1	9124 017 01915	9124 017 01989	24
	PHMG-V2C-600-074	Power supply, PHV,600W/7.4A,M19	1	9124 017 01912	9124 017 01986	33
	PHWG-V2C-600-074	Power supply, HVG,600W/7.4A,WLD	1	9124 017 01908	9124 017 01982	33
C	CDG-RMU24AFP6M1.2	4-Bar Right Angle DC Splitter, 4-FT Trunk	4	9124 017 02114	9124 017 02130	10
D	CDG-RMU24PPF9M1.4	4-port DC Manifold Cable, 4-FT Trunk	1	9124 017 02125	9124 017 02141	10
E	CDG-RMU24SFP6M1.2	4-Bar Straight DC Splitter, 4-FT Trunk	4	9124 017 02117	9124 017 02133	10
F	FF-RM-6S-2F	Fixture Frame Kit, 6" bar spacing, 2ft	6	9124 017 02103	N/A	N/A
G	FF-RM-6S-4F	Fixture Frame Kit, 6" bar spacing, 4ft	3	9124 017 02105	N/A	N/A

PARTS

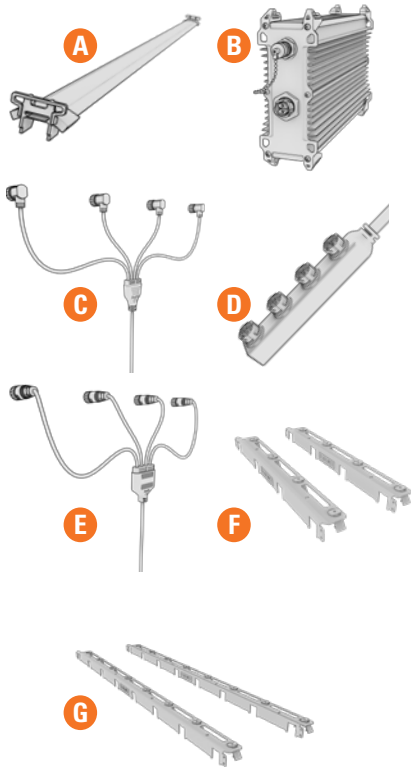

DC CABLE WIRING DIAGRAM

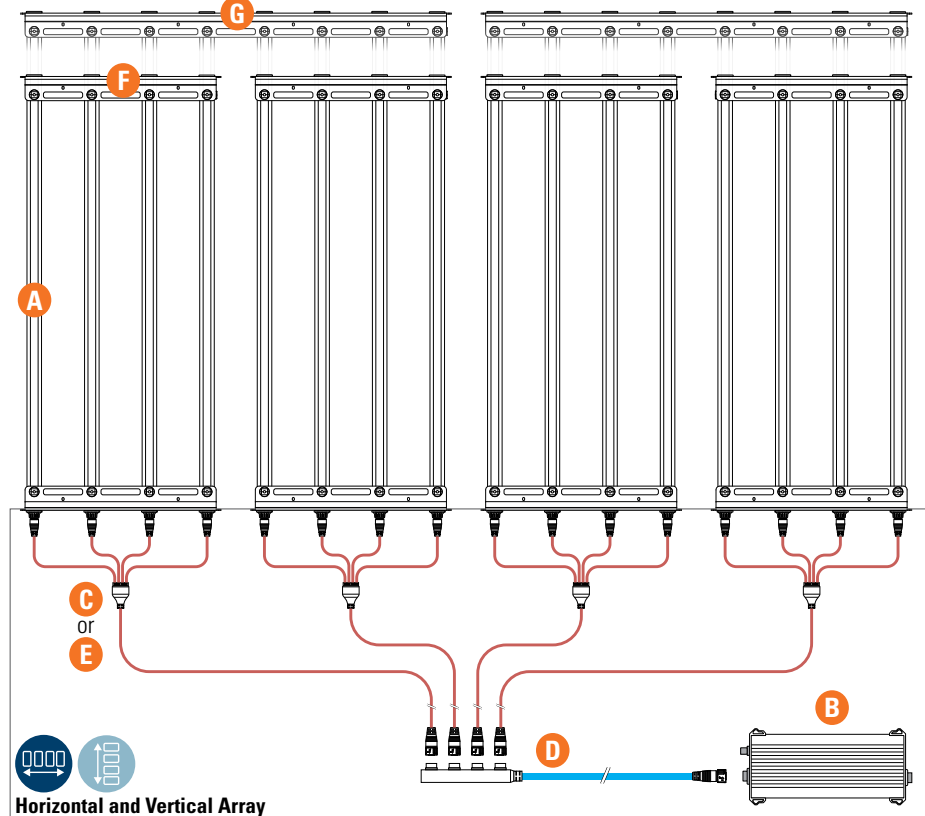

12-Bar RAZR Modular Systems

(3) 4-Bar Fixtures

Fixture Array | Number of Fixtures per Power Supply

2'x4' 4-Bar	
3 Fixtures	
Installation	Pre-Configured Systems
Horizontal Array	RM-44SLBW3-4A3LV-S/ RM-44SLBW3-4A3HV-S RM-48SLBW3-4A3LV-S/ RM-48SLBW3-4A3HV-S RM-48SLBW4-4A3LV-S/ RM-48SLBW4-4A3HV-S
Vertical Array	RM-44SLBW3-4S3LV-S/ RM-44SLBW3-4S3HV-S RM-48SLBW3-4S3LV-S/ RM-48SLBW3-4S3HV-S RM-48SLBW4-4S3LV-S/ RM-48SLBW4-4S3HV-S



RAZR MODULAR COMPONENTS

Component	RCC	Part Description	QTY per system	Ordering PN 12NC Single Pack (-S)	Ordering PN 12NC Bulk Pack (-B)	Bulk Pack Quantity
A	RM-44-S-BW3	44" Light Bar, BROAD R3, uniform LED spacing	12	9124 017 02031	9124 017 02041	288
	RM-44-SL-BW3	44" Enclosed Light Bar, BROAD R3, uniform LED spacing	12	9124 017 02051	9124 017 02061	234
	RM-48-S-BW3	48" Light Bar, BROAD R3, uniform LED spacing	12	9124 017 02032	9124 017 02042	288
	RM-48-SL-BW3	48" Enclosed Light Bar, BROAD R3, uniform LED spacing	12	9124 017 02052	9124 017 02062	234
	RM-53-S-BW3	53" Light Bar, BROAD R3, uniform LED spacing	12	9124 017 02039	9124 017 02049	288
	RM-53-R-BW3	53" Light Bar, BROAD R3, redistributed LED spacing	12	9124 017 02040	9124 017 02050	288
	RM-53-SL-BW3	53" Enclosed Light Bar, BROAD R3, uniform LED spacing	12	9124 017 02059	9124 017 02069	234
B	PLMG-V3B-320-056	Power supply, LVG,320W/5.6A,M19	1	9124 017 02021	9124 017 02022	30
	PHMG-V3B-320-056	Power supply, HVG,320W/5.6A,M19	1	9124 017 01909	9124 017 01983	30
C	CDG-RMU24AFP6M1.2	4-Bar Right Angle DC Splitter, 4-FT Trunk	3	9124 017 02114	9124 017 02130	10
D	CDG-RMU24FP9M1.4	4-port DC Manifold Cable, 4-FT Trunk	1	9124 017 02125	9124 017 02141	10
E	RM-MDC	Manifold Port Dust Cap (covering unused ports)	1	9124 017 02328	9124 017 02329	100
F	CDG-RMU24SFP6M1.2	4-Bar Straight DC Splitter, 4-FT Trunk	3	9124 017 02117	9124 017 02133	10
G	FF-RM-6S-2F	Fixture Frame Kit, 6" bar spacing, 2ft	3	9124 017 02103	N/A	N/A

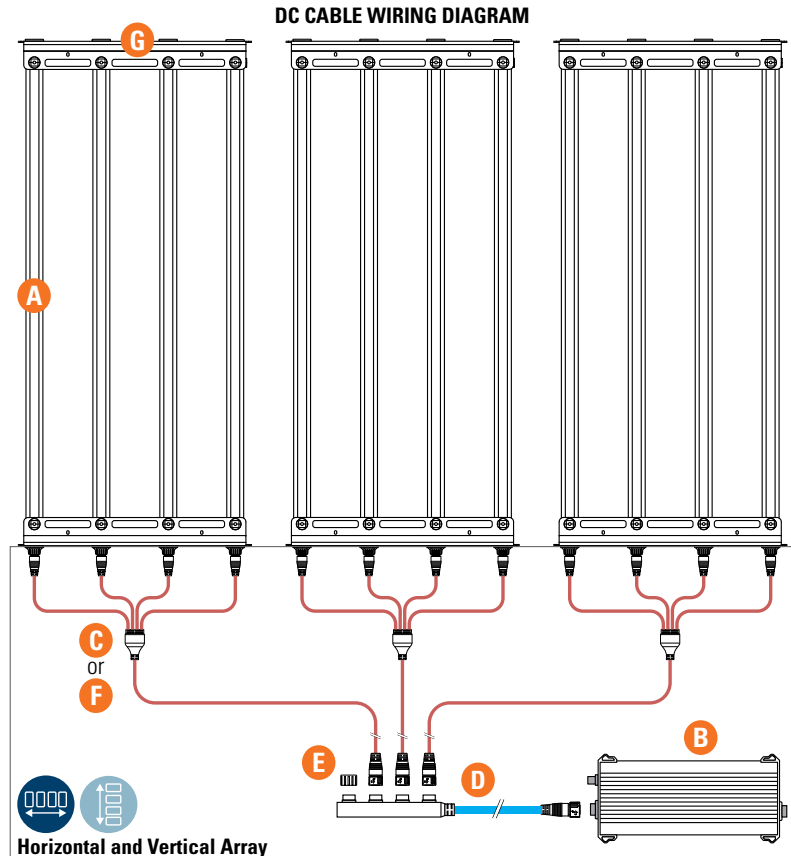
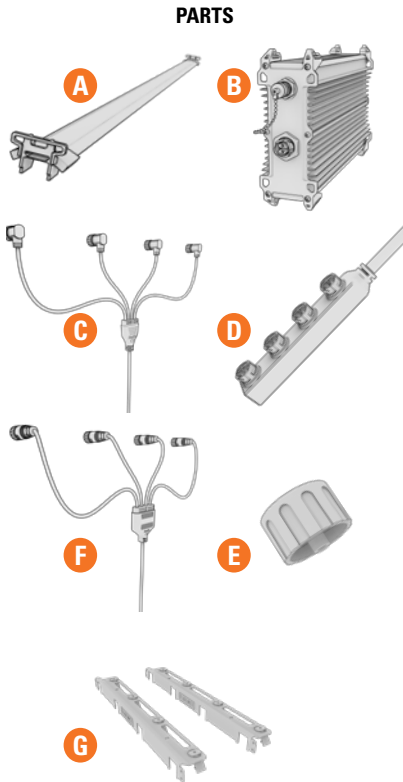

8-Bar RAZR Modular Systems

(2) 4-Bar Fixtures or (1) 8-Bar Fixtures

Fixture Array | Number of Fixtures per Power Supply

2'x4' 4-Bar	4'x4' 8-Bar
2 Fixtures	1 Fixture
Installation	
Pre-Configured Systems	
Horizontal Array	None
Vertical Array	None



RAZR MODULAR COMPONENTS

Component	RCC	Part Description	QTY per system	Ordering PN 12NC Single Pack (-S)	Ordering PN 12NC Bulk Pack (-B)	Bulk Pack Quantity
A	RM-44-S-BW3	44" Light Bar, BROAD R3, uniform LED spacing	8	9124 017 02031	9124 017 02041	288
	RM-44-SL-BW3	44" Enclosed Light Bar, BROAD R3, uniform LED spacing	8	9124 017 02051	9124 017 02061	234
	RM-48-S-BW3	48" Light Bar, BROAD R3, uniform LED spacing	8	9124 017 02032	9124 017 02042	288
	RM-48-SL-BW3	48" Enclosed Light Bar, BROAD R3, uniform LED spacing	8	9124 017 02052	9124 017 02062	234
	RM-53-S-BW3	53" Light Bar, BROAD R3, uniform LED spacing	8	9124 017 02039	9124 017 02049	288
	RM-53-R-BW3	53" Light Bar, BROAD R3, redistributed LED spacing	8	9124 017 02040	9124 017 02050	288
	RM-53-SL-BW3	53" Enclosed Light Bar, BROAD R3, uniform LED spacing	8	9124 017 02059	9124 017 02069	234
	RM-53-RL-BW3	53" Enclosed Light Bar, BROAD R3, redistributed LED spacing	8	9124 017 02060	9124 017 02070	234
B	PLMG-V3B-320-037	Power supply, LVG,320W/3.7A,M19	1	9124 017 01917	9124 017 01991	30
	PHMG-V3B-320-037	Power supply, HVG,320W/3.7A,M19	1	9124 017 02028	9124 017 02027	30
C	CDG-RMU24AFP6M1.2	4-Bar Right Angle DC Splitter, 4-FT Trunk	2	9124 017 02114	9124 017 02130	10
D	CDG-RMU24PFP9M1.4	4-port DC Manifold Cable, 4-FT Trunk	1	9124 017 02125	9124 017 02141	10
E	RM-MDC	Manifold Port Dust Cap (covering unused ports)	2	9124 017 02328	9124 017 02329	100
F	CDG-RMU24SFP6M1.2	4-Bar Straight DC Splitter, 4-FT Trunk	2	9124 017 02117	9124 017 02133	10
G	FF-RM-6S-2F	Fixture Frame Kit, 6" bar spacing, 2ft	2	9124 017 02103	N/A	N/A
H	FF-RM-6S-4F	Fixture Frame Kit, 6" bar spacing, 4ft	1	9124 017 02105	N/A	N/A

PARTS

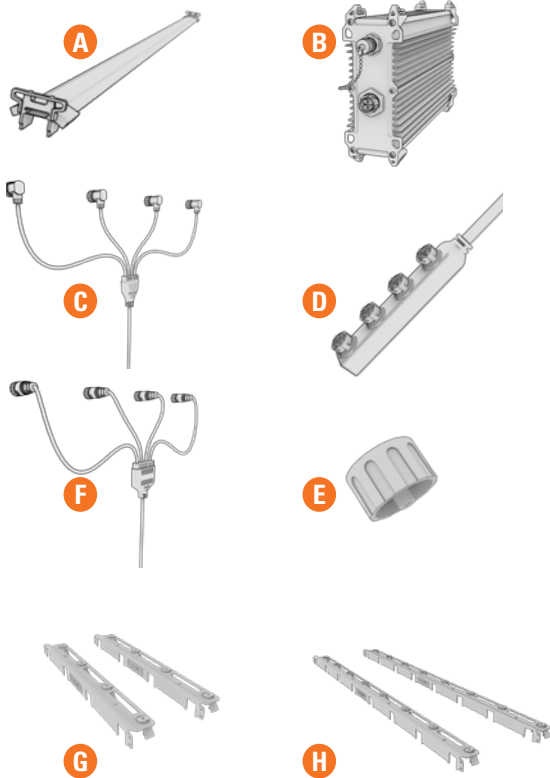

DC CABLE WIRING DIAGRAM

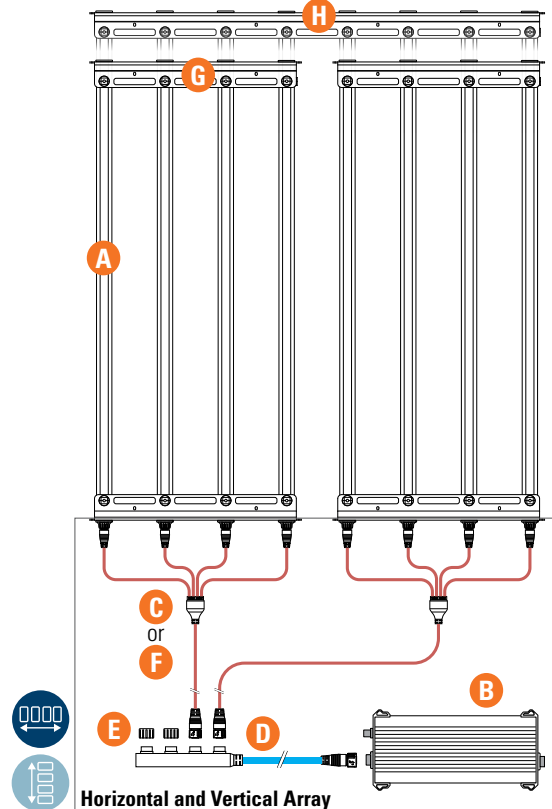

DC SPLITTER CABLES

	Description	Regional Commercial Code	Ordering PN 12NC Single Pack (S)	Ordering PN 12NC Bulk Pack (B)	Bulk Pack Carton Quantity
A	2-Bar Right Angle DC Splitter, 4 ft [1,2 m] Trunk	CDG-RMU22AFP6M1.2	9124 017 02112	9124 017 02128	10
B	3-Bar Right Angle DC Splitter, 4 ft [1,2 m] Trunk	CDG-RMU23AFP6M1.2	9124 017 02113	9124 017 02129	10
C	4-Bar Right Angle DC Splitter, 4 ft [1,2 m] Trunk	CDG-RMU24AFP6M1.2	9124 017 02114	9124 017 02130	10
D	2-Bar Straight DC Splitter, 4 ft [1,2 m] Trunk	CDG-RMU22SFP6M1.2	9124 017 02115	9124 017 02131	10
E	3-Bar Straight DC Splitter, 4 ft [1,2 m] Trunk	CDG-RMU23SFP6M1.2	9124 017 02116	9124 017 02132	10
F	4-Bar Straight DC Splitter, 4 ft [1,2 m] Trunk	CDG-RMU24SFP6M1.2	9124 017 02117	9124 017 02133	10
G	2-Bar RT In Line DC Splitter, 4 ft [1,2 m] Trunk	CDG-RMU22RFP6M1.2	9124 017 02118	9124 017 02134	10
H	3-Bar RT In Line DC Splitter, 4 ft [1,2 m] Trunk	CDG-RMU23RFP6M1.2	9124 017 02119	9124 017 02135	10
I	4-Bar RT In Line DC Splitter, 4 ft [1,2 m] Trunk	CDG-RMU24RFP6M1.2	9124 017 02120	9124 017 02136	10

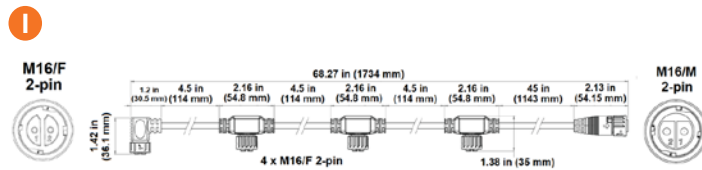
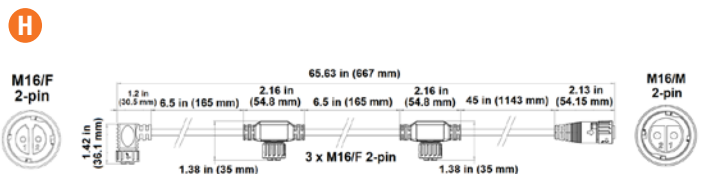
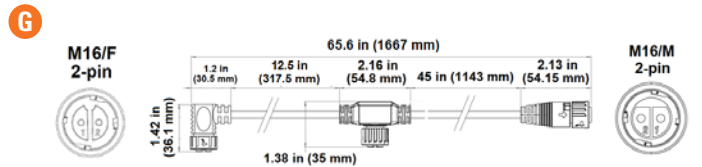
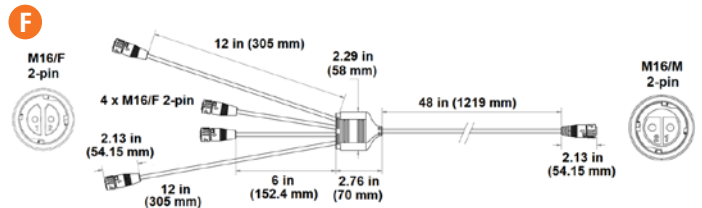
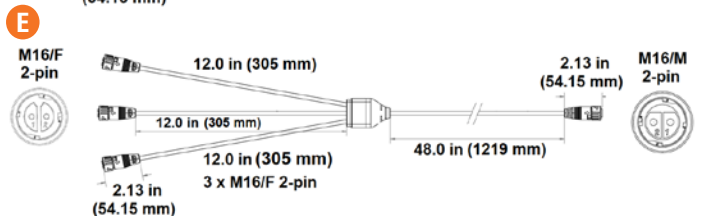
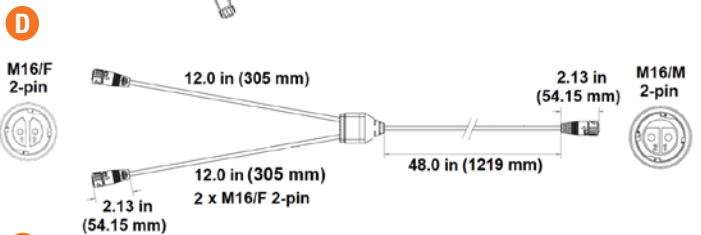
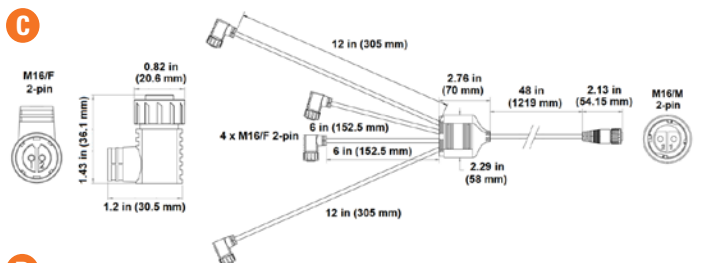
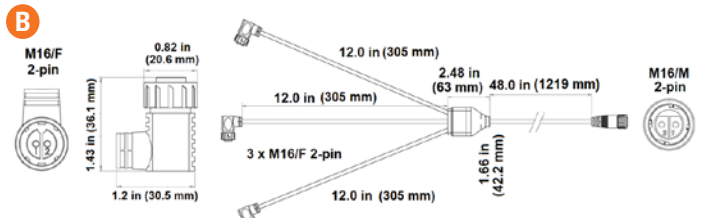
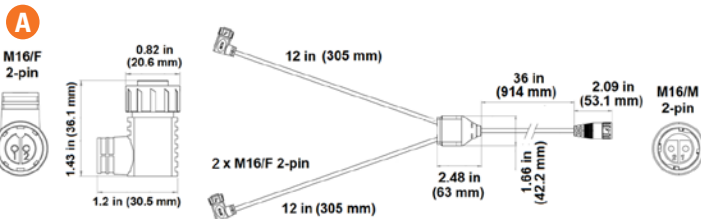

DC MANIFOLD CABLES

Description		Regional Commercial Code	Ordering PN 12NC Single Pack (S)	Ordering PN 12NC Bulk Pack (B)	Bulk Pack Carton Quantity
A	Manifold Splitter Cable, 3 ft [0,9 m]	CDG-RMU2MSFP9M0.9	9124 017 02124	9124 017 02140	10
B	Manifold 4-Port Cable, 4 ft [1,2 m]	CDG-RMU24PPF9M1.4	9124 017 02125	9124 017 02141	10
C	Manifold 6-Port Cable, 4 ft [1,2 m]	CDG-RMU26PPF9M1.5	9124 017 02126	9124 017 02142	10
D	Manifold 8-Port Cable, 2 ft [0,6 m]	CDG-RMU28PPF9M0.9	9124 017 02127	9124 017 02143	10
E	RAZRm, Dust Cap, M16, Inner, Manifold	RM-MDC	9124 017 02328	9124 017 02329	100
F	RAZRm, Dust Cap, M16, Outer, Splitter Cables	RM-SDC	9124 017 02326	9124 017 02327	100

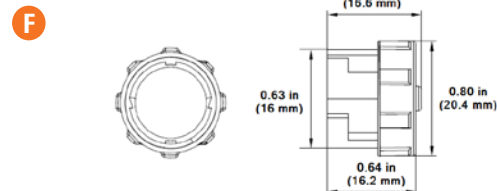
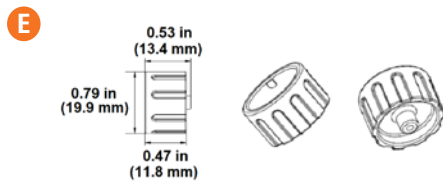
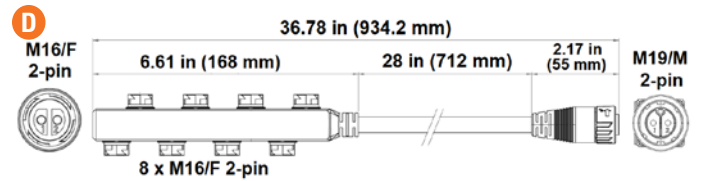
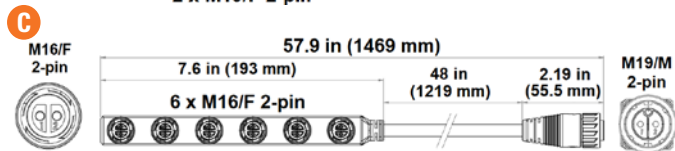
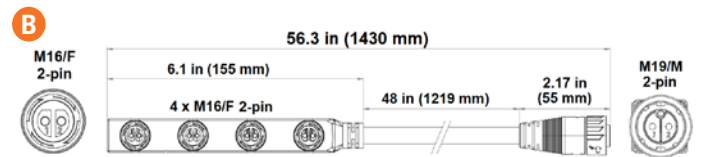
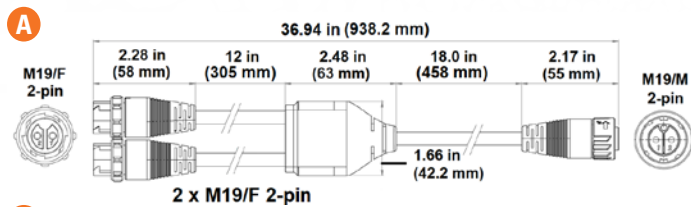

DC DIMMING SIGNAL CABLES (Power Supply to Dimming Control)

	Description	Regional Commercial Code	Ordering PN 12NC Single Pack (S)	Ordering PN 12NC Bulk Pack (B)	Bulk Pack Carton Quantity
A	11 IN (0.28 m) dimming signal cable, pigtail, M12 connector	CCA-XXU3T2FL3X0.3	9124 017 01621	9124 016 55902	10
B	5-FT (1.52 m) dimming signal cable, pigtail, M12 connector	CCA-XXU3T2FL3X1.5	9124 017 01622	9124 016 55881	10
C	80 cm (31.5 IN) dimming signal cable, Cca, pigtail, M12 connector (for Europe)	CCE-XXC3T2FL3X0.8	9124 017 01623	9124 016 55883	10

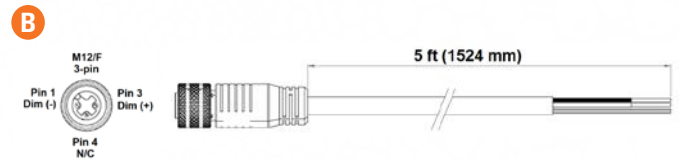
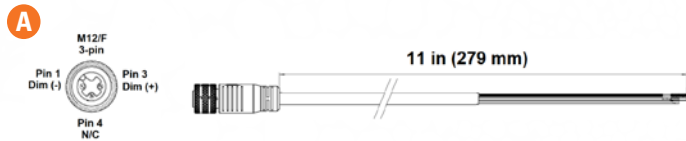

AC POWER CABLES - AMERICAS (Power Supply to AC Line)

	Description	Regional Commercial Code	Ordering PN 12NC Single Pack (S)	Ordering PN 12NC Bulk Pack (B)	Bulk Pack Carton Quantity
A	6-FT (1.83 m) AC Extension Cable, NEMA 5-15P Plug, M19 Push Lock, Max 125 V AC	CAA-XXU3P9FN5P1.8	9124 017 01611	9124 016 88454	10
B	6-FT (1.83 m) AC Extension Cable, NEMA 6-15P Plug, M19 Push Lock, Max 250 V AC	CAA-XXU3P9FN6P1.8	9124 017 01613	9124 016 88456	10
C	6-FT (1.83 m) AC Extension Cable, NEMA L7-15P Plug, M19 Push Lock, Max 277 V AC	CAA-XXU3P9FL7P1.8	9124 017 01625	9124 016 55898	10
D	6-FT (1.83 m) AC Extension Cable, Pigtail, M19 Push Lock, Max 480 V AC	CAA-XXU3P9FL3X1.8	9124 017 01624	9124 016 55875	10
E	15-FT (4.57 m) AC Extension Cable, NEMA 5-15P Plug, M19 Push Lock, Max 125 V AC	CAA-XXU3P9FN5P4.6	9124 017 01612	9124 016 88455	5
F	15-FT (4.57 m) AC Extension Cable, NEMA 6-15P Plug, M19 Push Lock, Max 250 V AC	CAA-XXU3P9FN6P4.6	9124 017 01614	9124 016 88457	5
G	15-FT (4.57 m) AC Extension Cable, NEMA L7-15P Plug, M19 Push Lock, Max 277 V AC	CAA-XXU3P9FL7P4.6	9124 017 01626	9124 016 55899	5
H	15-FT (4.57 m) AC Extension Cable, Pigtail, M19 Push Lock, Max 480 V AC	CAA-XXU3P9FL3X4.6	9124 017 01610	9124 016 88461	5
I	Wieland AC Connector Adapter for Power Supply, STW PVC, M19 Push Lock, 18-IN (0.46 m), Wieland Part #: 96.032.0053.1 (Male-Black) Note: Use Green Connector Cables 51756 and 71650 for EU	AAA-XXU3P9FWGM0.5	9124 016 56089	9124 016 56090	20

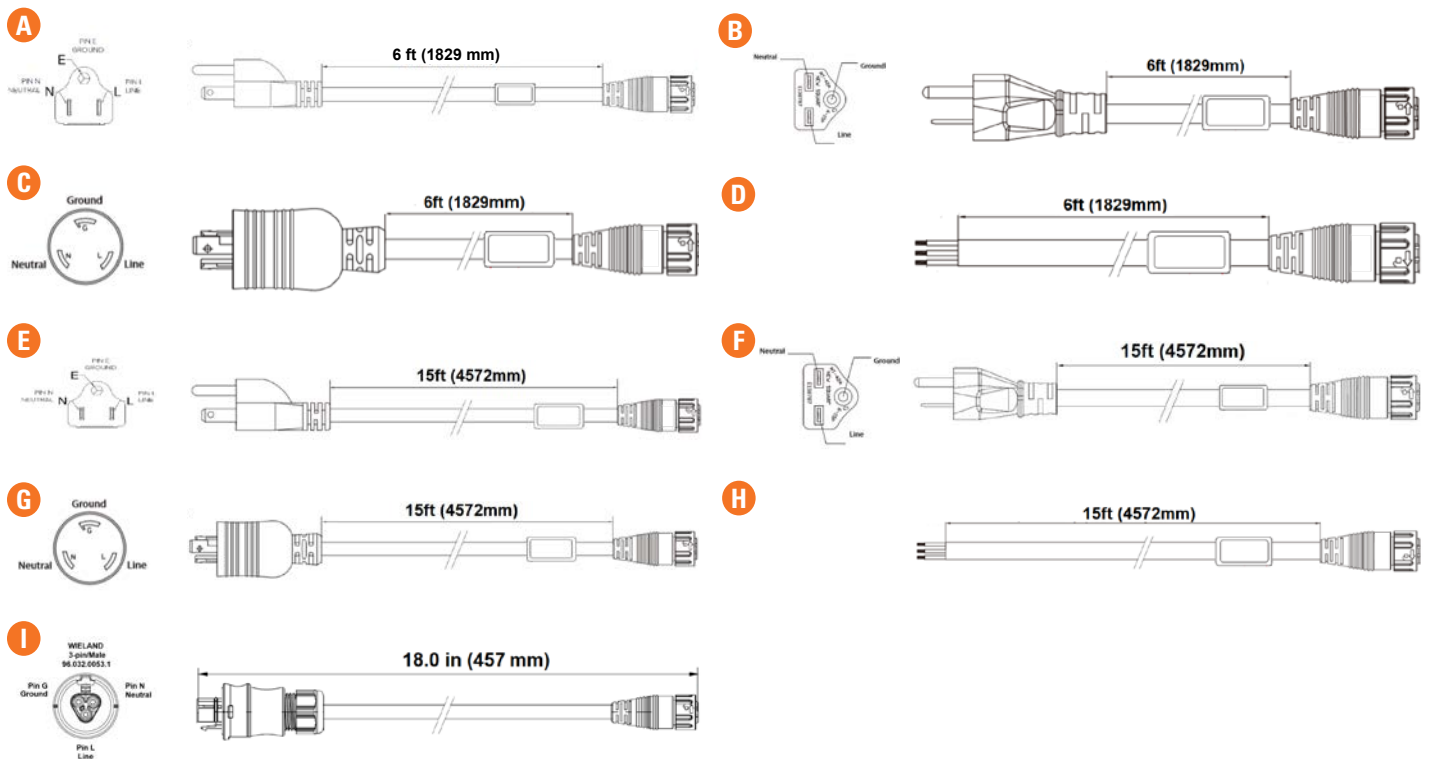

AC POWER CABLES - AMERICAS (Power Supply to AC Line)

	Description	Regional Commercial Code	Ordering PN 12NC Single Pack (S)	Ordering PN 12NC Bulk Pack (B)	Bulk Pack Carton Quantity
A	1,83 m (6 FT) AC Cable, VDE H07RN-F, Schuko Type F7 plug, M19 Push Lock, 230V AC	CAE-XXV3P9FF7P1.8	9124 017 01628	9124 016 55901	10
B	1,83 m (6 FT) AC Cable, VDE H07RN-F, pigtail, M19 Push Lock (not for CE countries)	CAR-XXV3P9FL3X1.8	9124 017 01616	9124 016 88464	10
C	4,57 m (15 FT) AC Cable, VDE H07RN-F, Schuko Type F7 plug, M19 Push Lock, 230V AC	CAE-XXV3P9FF7P4.6	9124 017 01615	9124 016 88463	5
D	4,57 m (15 FT) AC Cable, VDE H07RN-F, pigtail, M19 Push Lock (not for CE countries)	CAR-XXV3P9FL3X4.6	9124 017 01617	9124 016 88465	5
E	70 cm (27,6 IN) AC Cable, DCA, pigtail, M19 Push Lock (230/400V CE application)	CAE-XXD3P9FL3X0.7	9124 017 01627	9124 016 55887	10
F	80 cm (31,5 IN) AC Cable, DCA, pigtail (use with adapter cable) Wieland connector Part #: 20i30F B2 ZR1S H GN02 (Female-Green)	CAE-XXD3WVFL3X0.8	9124 016 56106	9124 016 56107	10
G	Wieland AC Connector Adapter for Power Supply, DCA cable, M19 Push Lock, 20 cm (8 IN), Wieland Part #: RST20i3F S2 ZR1SVH GN0 (Male-Green)	AAE-XXD3P9FWGM0.2	9124 017 01609	9124 016 88466	10
H	1,83 m (6 FT) AC Cable, VDE H07RN-F, Type SAA plug, M19 Push Lock, Max 250 V AC (AUS/NZ)	CAZ-XXS3P9FTIP1.8	9124 017 01618	9124 016 88467	10

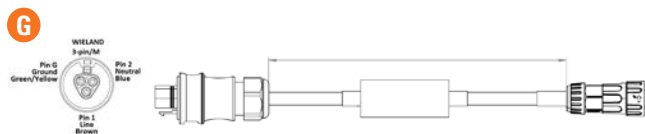
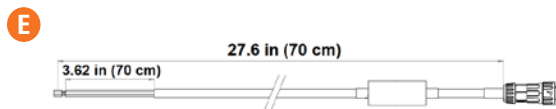
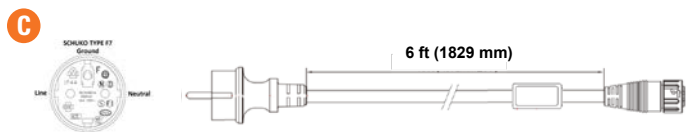
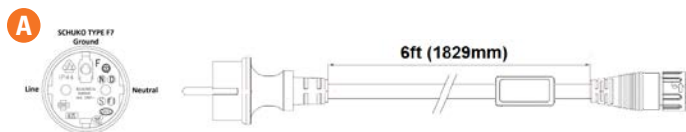

POWER SUPPLY WIRING

LVG AND HVG POWER SUPPLY

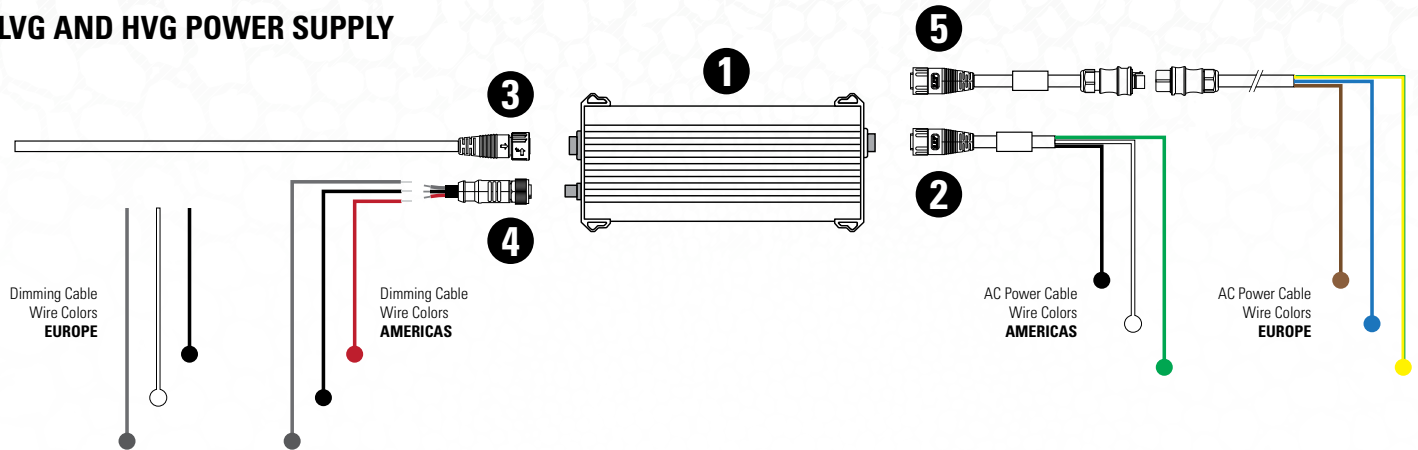

COMPONENTS

- 1** Power Supply
- 2** AC Power Cable to Power Supply
- 3** DC Power Cable to Light Fixtures (Refer to the **pages 3-18** for the DC Power Cabling for your configuration)
- 4** DC Dimming Signal Cable to Power Supply
- 5** Optional WIELAND© AC power cable adapters to Power Supply (i.e. p/n AAE-XXD3P9FWGM0.2) and Dca pigtail cable (i.e. p/n CAE-XXD3WGFL3X0.8), Green plug for Europe shown

2 5 AC POWER CABLE CONNECTIONS

Americas AC Cable Wire Colors	International AC Cable Wire Colors	Power Supply Pin Connection	LVG					HVG		
			120 V	208 V	230 V	240 V	277 V	347 V	400 V	480 V
Black	Brown	L	Phase	Phase	Phase	Phase	Phase	Phase	Phase	Phase
White	Blue	N	Neutral	Phase	Neutral	Phase	Neutral	Neutral	Phase	Phase
Green	Green-yellow	G	PE	PE	PE	PE	PE	PE	PE	PE

NOTE: In 3-phase power applications, the light fixtures/loads should be properly distributed across all three phases, and not all on the same phase.

4 DC DIMMING SIGNAL CABLE CONNECTIONS

Dimming Cable Wire Color Americas	Dimming Cable Wire Color Europe	Power Supply Pin Connection
Red	Black	DIM (+)
Black	White	DIM (-)
Bare Wire	Bare Wire	Shield Drain (not connected to PS)

NOTE: Connect the dim cable shield drain to only one PE ground connection point, i.e. at the dimming control panel.

DIMMING SPECIFICATIONS

Dimming Input	Off/on 0/1-10V Sink Dimming, Source Driver
Dimming Range	10-100 %, Linear
Typ / Max Source Current @ Vdim=0V	400 µA/ 500 µA
Voltage @ Full load	10 V
Voltage Dim to OFF	0.8 V
Voltage Dim to ON	1.0 V
Hysteresis (V / %)	0.2 V / 2 %

Power Supply Connector	Connector Type	Pin Assignments
AC Power Connector	Push-lock Male M19, 3-pin	Pin N: Neutral Pin L: Line Pin G: Ground
DC Power Connector	Push-lock Female M19, 2-Pin	Pin 1: LED (-) Pin 2: LED (+)
Dimming Connector	IEC61076-2-101 Threaded A-Code Male M12, 3-pin	Pin 1: Dim (-) Pin 3: Dim (+) *Pin 4: 12VDC+

WIELAND© is a copyright of Wieland Electric GmbH. All rights reserved.

*Not Connected to Dimming Cable

NOTE: Fluence recommends the use of AC circuit contactors to completely disconnect the facility AC voltage from the luminaire to mitigate potential glowing or dimming interruptions of the crop dark period. For more information, please download the Dim-to-Off Application Note available at the Fluence Support Center <https://fluence-led.com/support-center/>.

OUR PRODUCT GUARANTEE & WARRANTY

Every Fluence Lighting system is engineered and built by Fluence Bioengineering using state-of-the-art robotics and hand craftsmanship. All Fluence Lighting systems are guaranteed against manufacturing defects for five years from date of purchase. Fluence lighting systems comply with applicable standards and are intended to be used with Fluence power supplies, cables and mounting hardware. The use of Fluence lighting systems with power supplies, cables and mounting hardware by others will limit specifications and void the warranty. Contact us at support@fluence-led.com for more warranty information.

We stand behind our research, we stand behind our technology and we stand behind our clients. <https://fluence-led.com/warranty/>



Review our products, share your grow and stay abreast of the latest Fluence news and product releases through the channels below:



www.fluence-led.com