



RAZR MODULAR

Configurable Components

Designed for high-performance vertical farms, Fluence's award winning RAZR Modular System illuminates your crops from propagation to harvest, yielding remarkable savings on energy and maintenance.

FLEXIBLE PERFORMANCE

Fluence's proven PhysioSpec™ BROAD R3a is the optimal spectrum for propagation and full-cycle cultivation of a multitude of leafy greens, microgreens, herbs and other vegetables. In addition to the BROAD R3a white spectrum, RAZR Modular Fixtures is available in a range of 75-450 $\mu\text{mol}/\text{m}^2\cdot\text{s}^2$, with seven different spectra, three system lengths and an IP67 enclosed version for harsh environments.

FLEXIBLE MOUNTING

With a large selection of mounting accessories and plug & play cables, the RAZR Modular System features low profile, highly configurable fixtures for simple, seamless integration into a variety of vertical racks. Each individual light bar and all mounting accessories are field replaceable, reducing grower's maintenance and cost of ownership over years of farm operations.



SYSTEM TOPOLOGY

- Nominal power; 12 bars on 300W system, 24 bars on 600W system
- Max 24 bars per system; 300W system 12-24 bars, distributing power evenly across bars (suitable for low PPFD applications)
- For custom bar configurations at nominal power, a power set driver is available for 6, 8, 9, 15, 16, 18, 20 and 24 bars

For correct configurations and cabling, please contact your Fluence representative or choose from the selected pre-configured designs



HORIZONTAL ARRAY LAYOUT



VERTICAL ARRAY LAYOUT

SYSTEM COMPONENTS

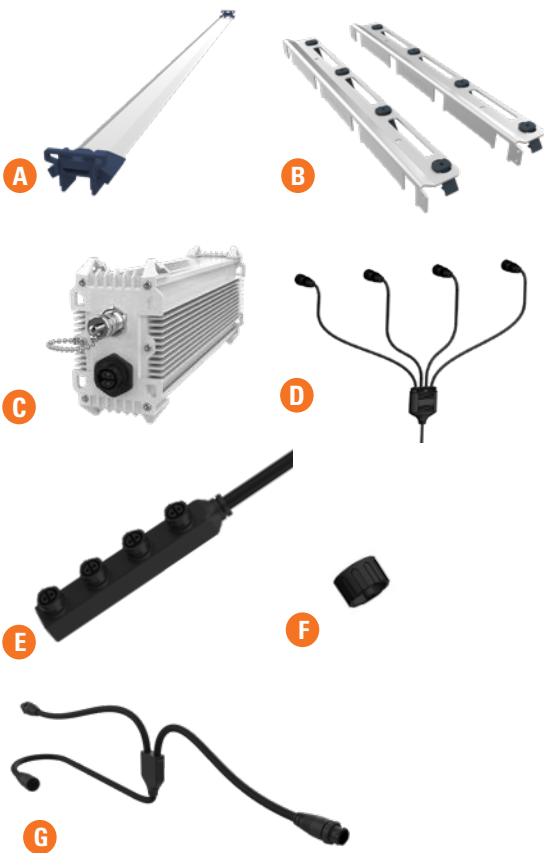

SYSTEM DIAGRAM

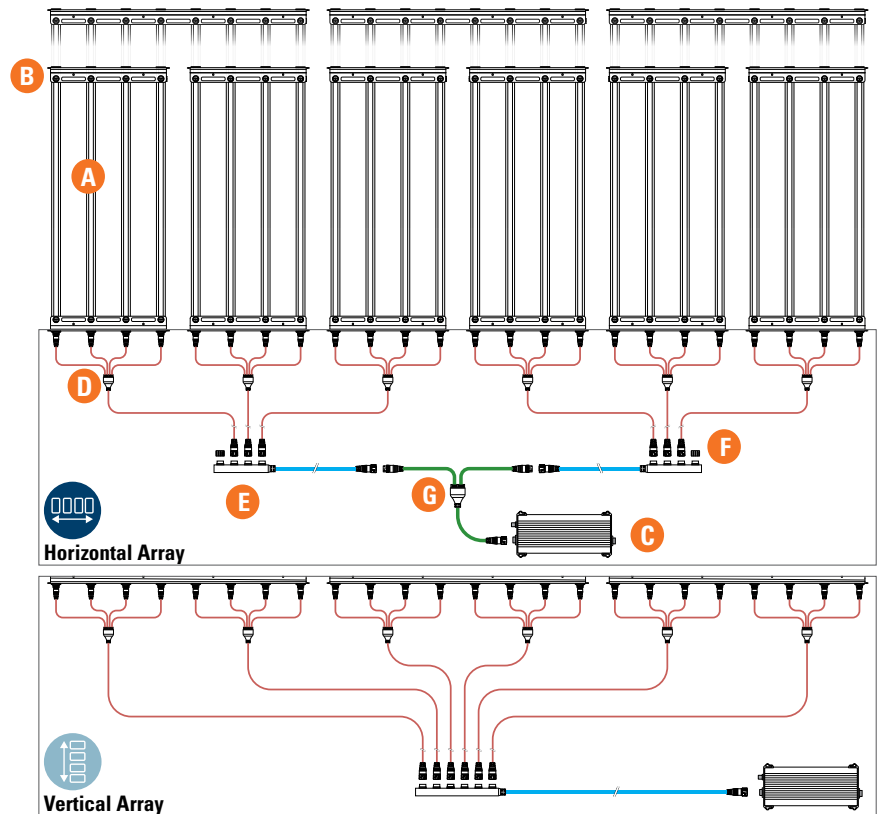

SPECTRA

PhysioSpec™ **BROAD R3a**

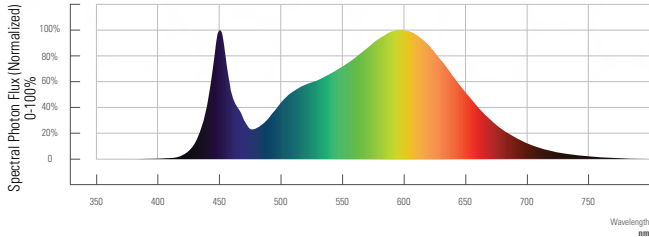

PhysioSpec™ **BROAD R4**

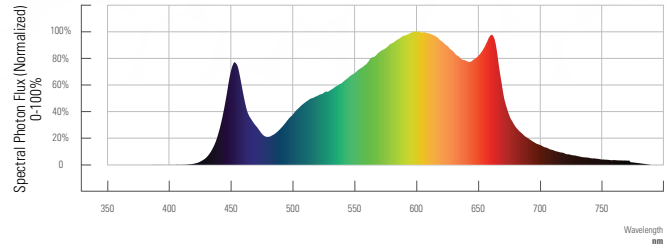

PhysioSpec™ **BROAD R6**

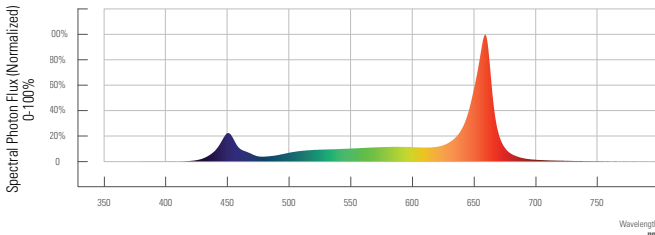

PhysioSpec™ **BROAD R8**

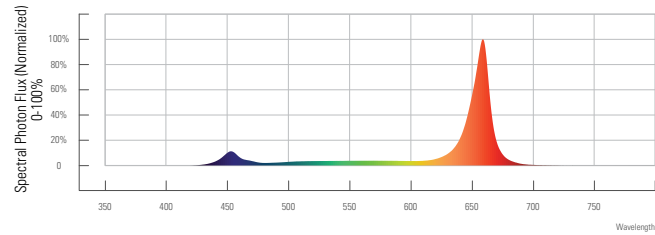

PhysioSpec™ **DUAL R9B**

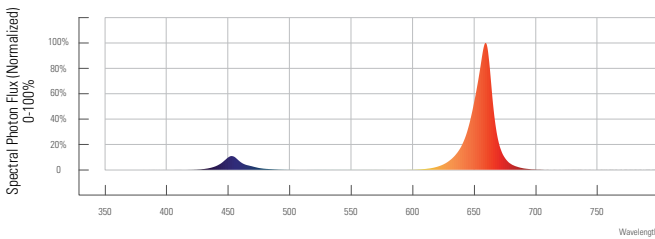

PhysioSpec™ **MONO RED (660nm)**

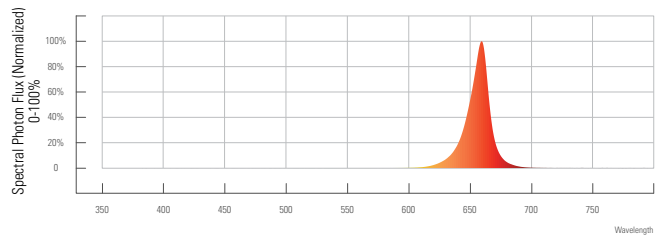

PhysioSpec™ **MONO FAR RED (730 nm)**

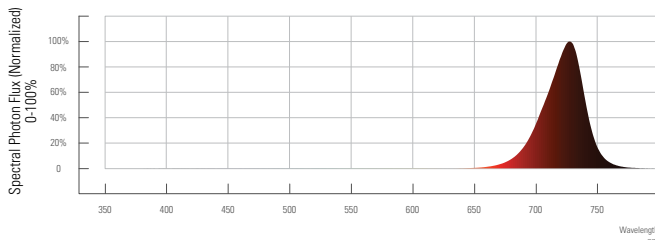

PhysioSpec™ Spectrum	Enclosure Type	Light Bar Output (μmol/s)	Efficacy (μmol/J)	SKU Abbreviation
BROAD R3a	No Enclosure	68	2.6	RM-48-S-BW3
	Enclosed	64	2.5	RM-48-SL-BW3
BROAD R4	No Enclosure	66	2.8	RM-48-S-BW4
	Enclosed	62	2.7	RM-48-SL-BW4
BROAD R6	No Enclosure	77	3.3	RM-48-S-BP6
	Enclosed	73	3.1	RM-48-SL-BP6
BROAD R8	No Enclosure	89	3.6	RM-48-S-BP8
	Enclosed	85	3.5	RM-48-SL-BP8
DUAL R9B	No Enclosure	92	3.9	RM-48-S-DR9
	Enclosed	87	3.7	RM-48-SL-DR9
MONO RED (600 nm)	No Enclosure	93	3.7	RM-48-S-MRD
	Enclosed	87	3.5	RM-48-SL-MRD
FAR RED (730 nm)	No Enclosure	74*	3.1*	RM-48-S-MFR
	Enclosed	70*	2.9*	RM-48-SL-MFR

*Based on total photon flux (wavelengths 400-800 nm)

Disclaimer: Performance values are from representative tests performed in accordance with industry standards listed. Actual application performance may vary due to component tolerances and installation, environmental, and field measurements conditions.

LIGHT BAR DIMENSIONS AND WEIGHT

Light Bar	Regional Commercial Code	Length	Width	Height	Mounting	Weight
44" open	RM-44-S-BW3	43" [110 cm]	1.8" [4,6 cm]	1.2" [3,0 cm]	42.5" [108 cm]	0.48 lb [0,22 kg]
44" enclosed	RM-44-SL-BW3	42.8" [109 cm]	1.9" [4,7 cm]	1.5" [3,8 cm]	42.7" [109 cm]	0.87 lb [0,39 kg]
48" open	RM-48-S-[Spectra]	46.2" [117 cm]	1.8" [4,6 cm]	1.2" [3,0 cm]	45.6" [116 cm]	0.51 lb [0,23 kg]
48" enclosed	RM-48-SL-[Spectra]	46" [116 cm]	1.9" [4,7 cm]	1.5" [3,8 cm]	45.8" [116 cm]	0.93 lb [0,42 kg]
53" open	RM-53-S-BW3/RM-53-R-BW3	52.3" [133 cm]	1.8" [4,6 cm]	1.2" [3,0 cm]	51.8" [131 cm]	0.57 lb [0,26 kg]
53" enclosed	RM-53-SL-BW3/RM-53-RL-BW3	52.1" [132 cm]	1.9" [4,7 cm]	1.5" [3,8 cm]	52.0" [132 cm]	1.04 lb [0,47 kg]

LIGHT BAR (NO ENCLOSURE S/R)

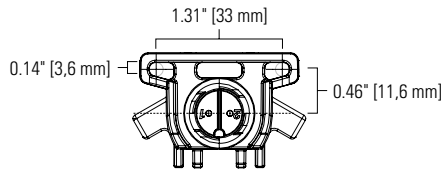
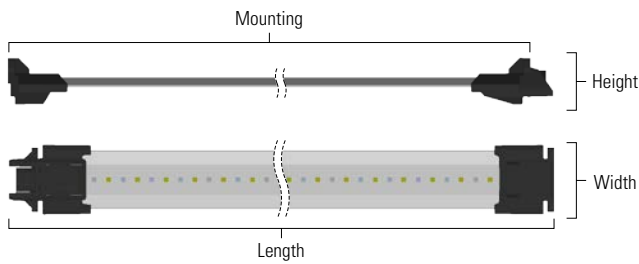

LIGHT BAR (ENCLOSED SL/RL)

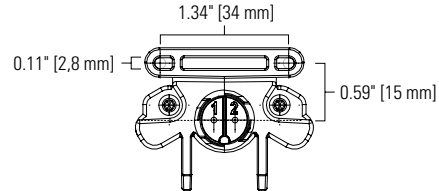
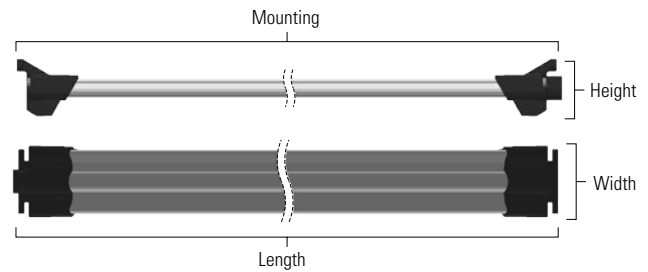

LIGHT BAR ORDERING PART NUMBERS

Description	Regional Commercial Code	Ordering PN 12NCs Single Pack (-S)	Ordering PN 12NCs Bulk Pack (-B)	Bulk Pack Quantity
RAZRm, Light Bar, 44", STD, Open, BW3	RM-44-BW3	9124 017 02031	9124 017 02041	288
RAZRm, Light Bar, 48", STD, Open, BW3	RM-48-BW3	9124 017 02032	9124 017 02042	288
RAZRm, Light Bar, 48", STD, Open, BW4	RM-48-BW4	9124 017 02033	9124 017 02043	288
RAZRm, Light Bar, 48", STD, Open, BP6	RM-48-BP6	9124 017 02034	9124 017 02044	288
RAZRm, Light Bar, 48", STD, Open, BP8	RM-48-BP8	9124 017 02035	9124 017 02045	288
RAZRm, Light Bar, 48", STD, Open, DR9	RM-48-DR9	9124 017 02036	9124 017 02046	288
RAZRm, Light Bar, 48", STD, Open, MFR	RM-48-MFR	9124 017 02037	9124 017 02047	288
RAZRm, Light Bar, 48", STD, Open, MRD	RM-48-MRD	9124 017 02038	9124 017 02048	288
RAZRm, Light Bar, 53", STD, Open, BW3	RM-53-BW3	9124 017 02039	9124 017 02049	288
RAZRm, Light Bar, 53", Ridistributed, Open, BW3	RM-53-R-BW3	9124 017 02040	9124 017 02050	288
RAZRm, Light Bar, 44", STD, Enclosed, BW3	RM-44L-BW3	9124 017 02051	9124 017 02061	234
RAZRm, Light Bar, 48", STD, Enclosed, BW3	RM-48L-BW3	9124 017 02052	9124 017 02062	234
RAZRm, Light Bar, 48", STD, Enclosed, BW4	RM-48L-BW4	9124 017 02053	9124 017 02063	234
RAZRm, Light Bar, 48", STD, Enclosed, BP6	RM-48L-BP6	9124 017 02054	9124 017 02064	234
RAZRm, Light Bar, 48", STD, Enclosed, BP8	RM-48L-BP8	9124 017 02055	9124 017 02065	234
RAZRm, Light Bar, 48", STD, Enclosed, DR9	RM-48L-DR9	9124 017 02056	9124 017 02066	234
RAZRm, Light Bar, 48", STD, Enclosed, MFR	RM-48L-MFR	9124 017 02057	9124 017 02067	234
RAZRm, Light Bar, 48", STD, Enclosed, MRD	RM-48L-MRD	9124 017 02058	9124 017 02068	234
RAZRm, Light Bar, 53", STD, Enclosed, BW3	RM-53L-BW3	9124 017 02059	9124 017 02069	234
RAZRm, Light Bar, 53", Ridistributed, Enclosed, BW3	RM-53-RL-BW3	9124 017 02060	9124 017 02070	234

POWER SUPPLY DIMENSIONS AND WEIGHT

Power Supply	Regional Commercial Code	Length	Width	Height	Weight	Figure
120-277V AC PSU 365/438/511/584 W DC	PLMG-V3A-600-xxx	12.9" [32,9 cm]	5.3" [13,4 cm]	2.6" [6,7 cm]	8.1 lb [3,7 kg]	A
277-480V AC PSU 365/438/511/584 W DC	PHMG-V2C-600-xxx	10" [25,4 cm]	6.4" [16,3 cm]	2.4" [6,3 cm]	7.5 lb [3,4 kg]	B
120-277 V AC PSU 146/219/292 W DC	PLMG-V3B-320-xxx	11.3" [28,8 cm]	4.3" [10,9 cm]	2.9" [7,3 cm]	5.8 lb [2,6 kg]	A
277-480V AC PSU 146/219/292 W DC	PHMG-V3B-320-xxx	11.3" [28,8 cm]	4.3" [10,9 cm]	2.9" [7,3 cm]	5.8 lb [2,6 kg]	A

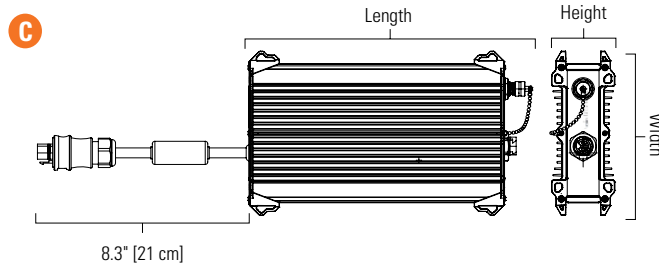
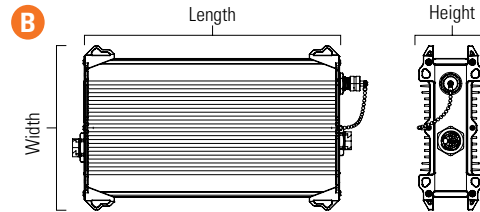
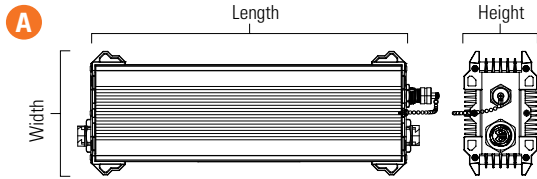

Standard configurations at nominal output:

- 12 bars – 300W driver
- 24 bars – 600W driver

Under-driven configurations:

- 15-24 bars on a 300W driver

Less than 12/24 bars at nominal power of PSU:

- Power-set driver

POWER SUPPLIES ORDERING PART NUMBERS (120-277V)

Number of Light Bars/ System	Wattage/ Bar	AC Connector Type	System DC Power	DC Current	Regional Commercial Code	Ordering PN 12NC Single Pack (-S)	Ordering PN 12NC Bulk Pack (-B)	Bulk Pack Pallet Quantity
6	24 W	M19	146 W DC	2.8 A	PLMG-V3B-320-028	9124 017 01918	9124 017 01992	30
8	24 W	M19	195 W DC	3.7 A	PLMG-V3B-320-037	9124 017 01917	9124 017 01991	30
9	24 W	M19	219 W DC	4.2 A	PLMG-V3B-320-042	9124 017 02023	9124 017 02024	30
12	24 W	M19	292 W DC	5.6 A	PLMG-V3B-320-056	9124 017 02021	9124 017 02022	30
15	24 W	M19	365 W DC	6.9 A	PLMG-V3A-600-069	9124 017 01916	9124 017 01990	24
16	24 W	M19	389 W DC	7.4 A	PLMG-V3A-600-074	9124 017 01915	9124 017 01912	24
18	24 W	M19	438 W DC	8.3 A	PLMG-V3A-600-083	9124 017 01915	9124 017 01989	24
20	24 W	M19	487 W DC	9.3 A	PLMG-V3A-600-093	9124 017 02001	9124 017 01999	24
21	24 W	M19	511 W DC	9.7 A	PLMG-V3A-600-097	9124 017 02013	9124 017 02014	24
24	24 W	M19	584 W DC	11.1 A	PLMG-V3A-600-111	9124 017 01914	9124 017 01988	24

POWER SUPPLIES ORDERING PART NUMBERS (277-480V)

Number of Light Bars/ System	Wattage/ Bar	AC Connector Type	System DC Power	DC Current	Regional Commercial Code	Ordering PN 12NC Single Pack (-S)	Ordering PN 12NC Bulk Pack (-B)	Bulk Pack Pallet Quantity
6	24 W	M19	146 W DC	2.8 A	PHMG-V3B-320-028	9124 017 02030	9124 017 02029	30
8	24 W	M19	195 W DC	3.7 A	PHMG-V3B-320-037	9124 017 02028	9124 017 02027	30
9	24 W	M19	219 W DC	4.2 A	PHMG-V3B-320-042	9124 017 02026	9124 017 02025	30
12	24 W	M19	292 W DC	5.6 A	PHMG-V3B-320-056	9124 017 01909	9124 017 01983	30
15	24 W	M19	365 W DC	6.9 A	PHMG-V2C-600-069	9124 017 01913	9124 017 01987	33
16	24 W	M19	389 W DC	7.4 A	PHMG-V2C-600-074	9124 017 01912	9124 017 01986	33
18	24 W	M19	438 W DC	8.3 A	PHMG-V2C-600-083	9124 017 01911	9124 017 01985	33
20	24 W	M19	487 W DC	9.3 A	PHMG-V2C-600-093	9124 017 02019	9124 017 02020	33
21	24 W	M19	511 W DC	9.7 A	PHMG-V2C-600-097	9124 017 02017	9124 017 02018	33
24	24 W	M19	584 W DC	11.1 A	PHMG-V2C-600-111	9124 017 01910	9124 017 01984	33
15	24 W	Wieland	365 W DC	6.9 A	PHWG-V2C-600-069	9124 017 02207	9124 017 02212	33
16	24 W	Wieland	389 W DC	7.4 A	PHWG-V2C-600-074	9124 017 01908	9124 017 01982	33
18	24 W	Wieland	438 W DC	8.3 A	PHWG-V2C-600-083	9124 017 02206	9124 017 02211	33
20	24 W	Wieland	487 W DC	9.3 A	PHWG-V2C-600-093	9124 017 02205	9124 017 02210	33
21	24 W	Wieland	511 W DC	9.7 A	PHWG-V2C-600-097	9124 017 02204	9124 017 02209	33
24	24 W	Wieland	584 W DC	11.1 A	PHWG-V2C-600-111	9124 017 02203	9124 017 02208	33

DC CABLE SPLITTERS ORDERING PART NUMBERS

Description	Regional Commercial Code	Ordering PN 12NC Single Pack (S)	Ordering PN 12NC Bulk Pack (B)	Bulk Pack Carton Quantity	Figure
2-Bar Right Angle DC Splitter, 4 ft [1,2 m] Trunk	CDG-RMU22AFP6M1.2	9124 017 02112	9124 017 02128	10	A
3-Bar Right Angle DC Splitter, 4 ft [1,2 m] Trunk	CDG-RMU23AFP6M1.2	9124 017 02113	9124 017 02129	10	B
4-Bar Right Angle DC Splitter, 4 ft [1,2 m] Trunk	CDG-RMU24AFP6M1.2	9124 017 02114	9124 017 02130	10	C
2-Bar Straight DC Splitter, 4 ft [1,2 m] Trunk	CDG-RMU22SFP6M1.2	9124 017 02115	9124 017 02131	10	D
3-Bar Straight DC Splitter, 4 ft [1,2 m] Trunk	CDG-RMU23SFP6M1.2	9124 017 02116	9124 017 02132	10	E
4-Bar Straight DC Splitter, 4 ft [1,2 m] Trunk	CDG-RMU24SFP6M1.2	9124 017 02117	9124 017 02133	10	F
2-Bar RT In Line DC Splitter, 4 ft [1,2 m] Trunk	CDG-RMU22RFP6M1.2	9124 017 02118	9124 017 02134	10	G
3-Bar RT In Line DC Splitter, 4 ft [1,2 m] Trunk	CDG-RMU23RFP6M1.2	9124 017 02119	9124 017 02135	10	H
4-Bar RT In Line DC Splitter, 4 ft [1,2 m] Trunk	CDG-RMU24RFP6M1.2	9124 017 02120	9124 017 02136	10	I

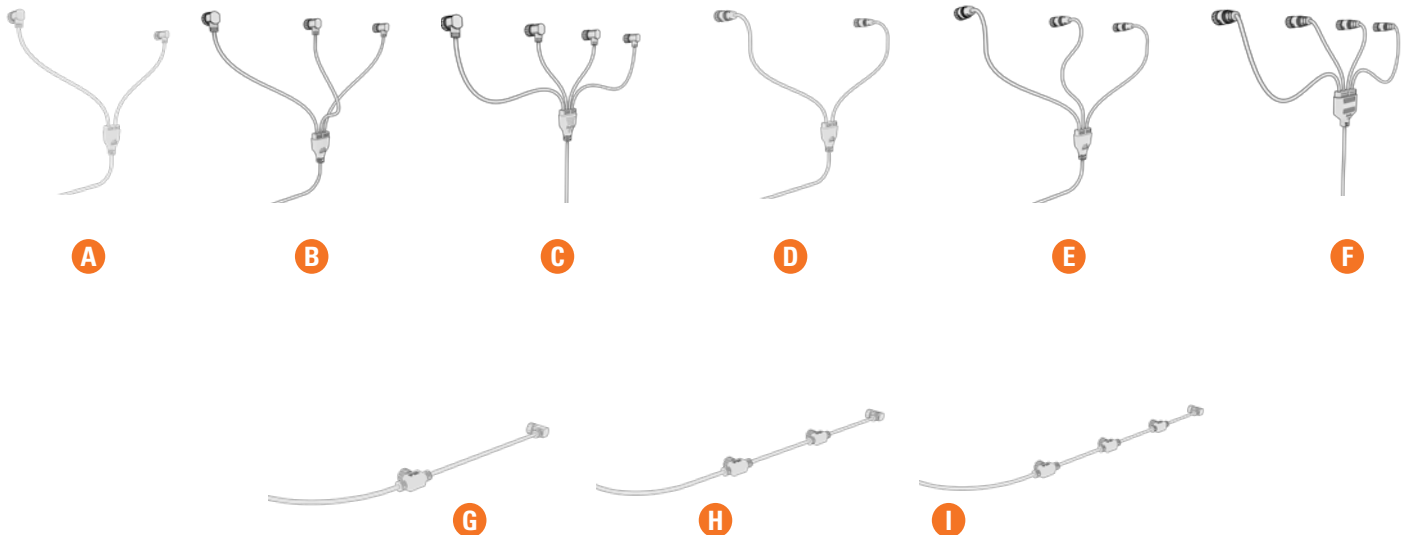

DC CABLE SPLITTERS ORDERING PART NUMBERS

Description	Regional Commercial Code	Ordering PN 12NC Single Pack (-S)	Ordering PN 12NC Bulk Pack (-B)	Bulk Pack Pallet Quantity	Figure
Manifold Splitter Cable, 3 ft [0,9 m]	CDG-RMU2MSFP9M0.9	9124 017 02124	9124 017 02140	10	A
Manifold 4-Port Cable, 4 ft [1,2 m]	CDG-RMU24PP9M1.4	9124 017 02125	9124 017 02141	10	B
Manifold 6-Port Cable, 4 ft [1,2 m]	CDG-RMU26PP9M1.5	9124 017 02126	9124 017 02142	10	C
Manifold 8-Port Cable, 2 ft [0,6 m]	CDG-RMU28PP9M0.9	9124 017 02127	9124 017 02143	10	D
RAZRm, Dust Cap, M16, Outer, Splitter Cables	RM-SDC	9124 017 02326	9124 017 02327	100	E
RAZRm, Dust Cap, M16, Inner, Manifold	RM-MDC	9124 017 02328	9124 017 02329	100	E



FIXTURE FRAMES

Description	Quantity per Fixture	Regional Commercial Code	Ordering PN 12NC Single Pack (-S)	Figure
3-Bar Fixture Frame Kit, 8" Bar Spacing	1 Kit (2 pcs)	FF-RM-8S-2F	9124 017 02102	A
4-Bar Fixture Frame Kit, 6" Bar Spacing	1 Kit (2 pcs)	FF-RM-6S-2F	9124 017 02103	B
6-Bar Fixture Frame Kit, 8" Bar Spacing	1 Kit (2 pcs)	FF-RM-8S-4F	9124 017 02104	C
8-Bar Fixture Frame Kit, 6" Bar Spacing	1 Kit (2 pcs)	FF-RM-6S-4F	9124 017 02105	D



FIXTURE HANGERS

Description	Length	QTY per Fixtures	Regional Commercial Code	Ordering PN 12NC Single Pack (-S)	Figure
Fixture Wire Hanger, Short - Baker's Rack	51 mm [2"]	1 Kit (4 pcs)	MR-RM-SH-XX	9124 017 02106	A
Fixture Wire Hanger, Medium - PIPP Rack	102 mm [4"]	1 Kit (4 pcs)	MR-RM-MH-XX	9124 017 02107	B
Fixture Wire Hanger, Long - Pallet Rack	191 mm [7.5"]	1 Kit (4 pcs)	MR-RM-LH-XX	9124 017 02108	C

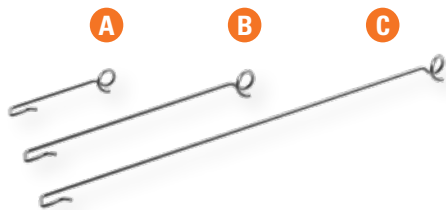

ADDITIONAL MOUNTING ACCESSORIES

Description	Regional Commercial Code	QTY per Light Bars	Ordering PN 12NC Single Pack (-S)	Ordering PN 12NC Bulk Pack (10 Kits)	Ordering PN 12NC Bulk Pack (100 Kits)	Figure
Universal Light Bar Clips	MR-RM-CU-XX	1 Kit (2 pcs)	9124 017 02098	9124 017 02099	9124 016 56023	A
Hanging Clip, 35 mm DIN Rail	MR-RM-CD-XX	1 Kit (2 pcs)	9124 017 02109	9124 017 02110	9124 017 02111	B
Universal Rail 44" [1,12 m] Long	MR-RM-UR-XX	1 Kit (2 pcs)	9124 017 02101	N/A	N/A	C



ACCESSORIES FOR POWER SUPPLY

Power Supply Mounting Hardware	Used with Power Supply	Regional Commercial Code	Ordering PN 12NC Single Pack (-S)	Ordering PN 12NC Bulk Pack (-B)	Bulk Pack Carton Quantity	Figure
PSU 292 W Power Supply Surface Mount Kit	PxMG-V3B-320-xxx	MS-PS-MB-3V	9124 016 56290	9124 016 56012	10 Kits	A
PSU LVG 584 W Power Supply Surface Mount Kit	PLMG-V3A-600-xxx	MS-PS-MB-LV	9124 016 56292	9124 016 56011	10 Kits	B
PSU HVG 584 W Power Supply Surface Mount Kit	PHxG-V2C-600-xxx	MS-PS-MB-HV	9124 016 56291	9124 016 56284	10 Kits	C

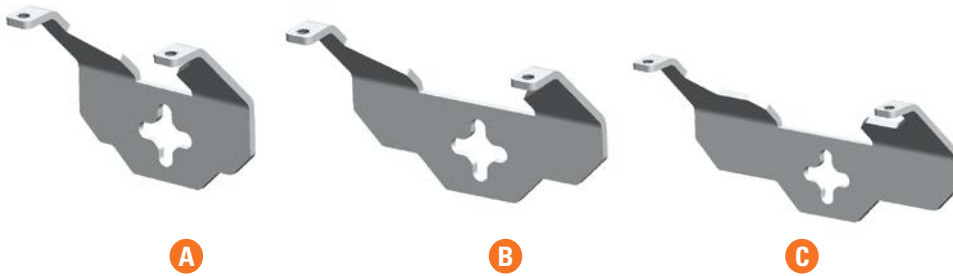

AC Power Cable - AMERICAS (Power Supply to AC Line)	Quantity per Power Supply	Regional Commercial Code	Ordering PN 12NC Single Pack (S)	Ordering PN 12NC Bulk Pack (B)	Bulk Pack Carton Quantity
6-FT (1.83 m) AC Cable, NEMA 5-15P Plug, M19 Push Lock, Max 125 V AC	1 Pc	CAA-XXU3P9FN5P1.8	9124 017 01611	9124 016 88454	10 Pcs
6-FT (1.83 m) AC Cable, NEMA 6-15P Plug, M19 Push Lock, Max 250 V AC	1 Pc	CAA-XXU3P9FN6P1.8	9124 017 01613	9124 016 88456	10 Pcs
6-FT (1.83 m) AC Cable, NEMA L7-15P Plug, M19 Push Lock, Max 277 V AC	1 Pc	CAA-XXU3P9FL7P1.8	9124 017 01625	9124 016 55898	10 Pcs
6-FT (1.83 m) AC Cable, Pigtail, M19 Push Lock, Max 480 V AC	1 Pc	CAA-XXU3P9FL3X1.8	9124 017 01624	9124 016 55875	10 Pcs
15-FT (4.57 m) AC Cable, NEMA 5-15P Plug, M19 Push Lock, Max 125 V AC	1 Pc	CAA-XXU3P9FN5P4.6	9124 017 01612	9124 016 88455	5 Pcs
15-FT (4.57 m) AC Cable, NEMA 6-15P Plug, M19 Push Lock, Max 250 V AC	1 Pc	CAA-XXU3P9FN6P4.6	9124 017 01614	9124 016 88457	5 Pcs
15-FT (4.57 m) AC Cable, NEMA L7-15P Plug, M19 Push Lock, Max 277 V AC	1 Pc	CAA-XXU3P9FL7P4.6	9124 017 01626	9124 016 55899	5 Pcs
15-FT (4.57 m) AC Cable, Pigtail, M19 Push Lock, Max 480 V AC	1 Pc	CAA-XXU3P9FL3X4.6	9124 017 01610	9124 016 88461	5 Pcs
Wieland AC Connector Adapter for Power Supply, STW PVC, M19 Push Lock, 18-IN (0.46 m), Wieland Part #: 96.032.0053.1 (Male)	1 Pc	AAA-XXU3P9FWGM0.5	9124 016 56089	9124 016 56090	20 Pcs

DC Dimming Signal Cable - AMERICAS (Power Supply to Dimming Control)	Quantity per Power Supply	Regional Commercial Code	Ordering PN 12NC Single Pack (S)	Ordering PN 12NC Bulk Pack (B)	Bulk Pack Carton Quantity
11-IN (0.28 m) Dimming Signal Cable, Pigtail, M12 Connector	1 Pc	CCA-XXU3T2FL3X0.3	9124 017 01621	9124 016 55902	10 Pcs
5-FT (1.52 m) Dimming Signal Cable, Pigtail, M12 Connector	1 Pc	CCA-XXU3T2FL3X1.5	9124 017 01622	9124 016 55881	10 Pcs

AC Power Cable - INTERNATIONAL (Power Supply to AC Line)	Quantity per Power Supply	Regional Commercial Code	Ordering PN 12NC Single Pack (S)	Ordering PN 12NC Bulk Pack (B)	Bulk Pack Carton Quantity
1,83 m (6 FT) AC Cable, VDE, Schuko Type F7 Plug, M19 Push Lock, 230 V AC	1 Pc	CAE-XXV3P9FF7P1.8	9124 017 01628	9124 016 55901	10 Pcs
1,83 m (6 FT) AC Cable, VDE, Pigtail, M19 Push Lock (Not for CE Countries)	1 Pc	CAR-XXV3P9FL3X1.8	9124 017 01616	9124 016 88464	10 Pcs
4,57 m (15 FT) AC Cable, VDE, Schuko Type F7 Plug, M19 Push Lock, 230 V AC	1 Pc	CAE-XXV3P9FF7P4.6	9124 017 01615	9124 016 88463	5 Pcs
4,57 m (15 FT) AC Cable, VDE, Pigtail, M19 Push Lock (Not for CE Countries)	1 Pc	CAR-XXV3P9FL3X4.6	9124 017 01617	9124 016 88465	5 Pcs
70 cm (27.6 IN) AC Cable, Dca, Pigtail, M19 Push Lock (400V CE Application)	1 Pc	CAE-XXD3P9FL3X0.7	9124 017 01627	9124 016 55887	10 Pcs
80 cm (31,5 IN) AC Cable, Dca, Pigtail (Use with Adapter Cable) Wieland Connector Part #: 20i30F B2 ZR1S H GN02 (Female)	1 Pc	CAE-XXD3WGFL3X0.8	9124 016 56106	9124 016 56107	10 Pcs
Wieland AC Connector Adapter for Power Supply, Dca Cable, M19 Push Lock, 20 cm (8 IN), Wieland Part #: RST20i3F S2 ZR1SVH GN0 (Male)	1 Pc	AAE-XXD3P9FWGM0.2	9124 017 01609	9124 016 88466	10 Pcs
1,83 m (6 FT) AC Cable, VDE, SAA 3-Prong Plug, M19 Push Lock, Max 250 V AC (Australia and New Zealand)	1 Pc	CAZ-XXS3P9FTIP1.8	9124 017 01618	9124 016 88467	10 Pcs

DC Dimming Signal Cable - INTERNATIONAL (Power Supply to Dimming Control)	Quantity per Power Supply	Regional Commercial Code	Ordering PN 12NC Single Pack (S)	Ordering PN 12NC Bulk Pack (B)	Bulk Pack Carton Quantity
80 cm (31,5 IN) Dimming Signal Cable, Cca, Pigtail, M12 Connector	1 Pc	CCE-XXC3T2FL3X0.8	9124 017 01623	9124 016 55883	10 Pcs

