



RAZR MODULAR

Light Bar Fixtures

Designed for high-performance vertical farms, Fluence's award winning RAZR Modular System illuminates your crops from propagation to harvest, yielding remarkable savings on energy and maintenance.

FLEXIBLE PERFORMANCE

Fluence's years of experience with vertical farm growers has proven BROAD R3a is the best spectrum for propagation and full-cycle cultivation of a multitude of leafy greens, microgreens, herbs and other vegetables. In addition to the BROAD R3a white spectrum, RAZR Modular is available in two bar lengths, three different bar spacing in an IP67 rated enclosed for harsh environments.

FLEXIBLE MOUNTING

With a large selection of mounting accessories and plug & play cables, the RAZR Modular System features low profile, highly configurable fixtures for simple, seamless integration into a variety of vertical racks. Each individual light bar and all mounting accessories are field replaceable, reducing grower's maintenance and cost of ownership over years of farm operations.

RAZR Modular

Light Bar Fixtures



SYSTEM SPECIFICATION

Bar Spacing	12" [30 cm], 8" [20 cm], 6" [15 cm]
Number of Light Bars per Frame	2, 3, 4, 6, 8
AC Input Power	150-600 W @ 277 V AC
AC Input Voltage	120-277 V, 277-480 V AC, 50/60 Hz
Power Factor*	> 0.98 (15-24 bars) and >0.92 (6-12 bars)
Total Harmonic Distortion (THD)*	< 10% (15-24 bars) and <20% (6-12 bars)
Dimming	Source Signal Driver, 0/1-10 V, OFF/ 10-100%
Max. Ambient Temperature	104°F / 40°C (95°F / 35°C @ 120 V AC)
Driver Lifetime at 40°C Ambient	> 50,000 hrs
Warranty	5 Year Limited
IP Rating per IEC 60598-1	IP66
Certifications	cETLus UL 8800, CE, Wet Location, DLC
DLC Reported Application and Use case	Indoor (Non-stacked), Indoor (Stacked) Top light/Sole-Source

LIGHT BAR SPECIFICATION

Light Output PPF (per bar)	62-120 μmol/s
Efficacy (Spectrum)	2.3-2.7 μmol/J
Nominal DC Wattage/Bar	24W, 50W
Light Distribution (Beam Angle)	120° Lambertian
Thermal Management	Passive
Lifetime LED Q90 (L90B50)	> 50,000 hrs
Thermal Management	Passive
IP Rating per IEC 60598-1	IP67

PhysioSpec™ Spectrum	Enclosure Type	Light Bar Output (μmol/s)	Efficacy (μmol/J)	SKU Abbreviation
BROAD R3a	Enclosed	64	2.5	RM-48-SL-BW3
BROAD R4	Enclosed	62	2.7	RM-48-SL-BW4

* @ 100% output. Contact factory for values over dimming range

SPECTRA

PhysioSpec™ **BROAD R3a**

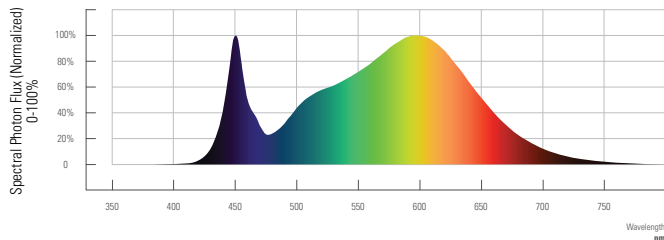

PhysioSpec™ **BROAD R4**

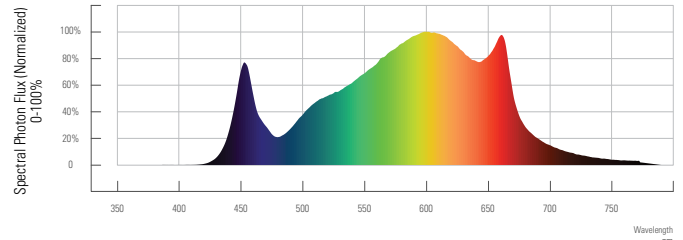

LIGHT BAR FIXTURE CONFIGURATIONS

Fixture includes light bars and DC cables (Splitters only).

FAMILY ¹		Light Bar Length ¹		LED Layout		Spectra ¹		Cable Type		Packaging	
RM	RAZR Modular	44	44"	SL	Standard Uniform Enclosed	BW3	BROAD R3a	2R	2-Bar with Right In-Line Connector (12" Spacing)	S	Single
		3A	3-Bar with Right Angle Connector (8" Spacing)								
		48	48"			3R	4-Bar with Right In-Line Connector (6" Spacing)	4A	4-Bar with Right Angle Connector (6" Spacing)		
						4R	4-Bar with Right In-Line Connector (6" Spacing)	6S	6-Bar with Straight Connector (8" Spacing)		
						BW4²	BROAD R4	8S	8-Bar with Straight Connector (6" Spacing)		

- Product listed on DLC QPL as DC powered module RM-48-xx-xxx (example: RM-48-SL-BW4)
- Spectrum BW4 only available with 48" light bar length.

Disclaimer: Performance values are from representative tests performed in accordance industry standards listed. Actual application performance may vary due to component tolerances and installation, environmental, and field measurements conditions.



Contact **FLUENCE** @
 support@fluence-led.com
 www.fluence-led.com/RAZR

RAZR MODULAR RACK SYSTEM SPECIFICATION

Fixture Type	Light Bar Spacing	Wattage/Bar	PPF per Fixture (400-700nm)	Number of Fixtures/System	System DC Power	System PPF (400-700nm)	AC Power (120-277V)	AC Current (120-277V)	AC Power (277-480V)	AC Current (277-480V)
2-Bar	12" [30 cm]	24 W	126 $\mu\text{mol/s}$	3 LB Frames	146 W DC	378 $\mu\text{mol/s}$	154-151 W	1.30-0.62 A	159-158 W	0.60-0.41 A
2-Bar	12" [30 cm]	24 W	126 $\mu\text{mol/s}$	4 LB Frames	195 W DC	504 $\mu\text{mol/s}$	204-200 W	1.72-0.78 A	208-206 W	0.78-0.50 A
2-Bar	12" [30 cm]	24 W	126 $\mu\text{mol/s}$	6 LB Frames	292 W DC	756 $\mu\text{mol/s}$	309-302 W	2.60-1.12 A	310-306 W	1.15-0.68 A
2-Bar	12" [30 cm]	24 W	126 $\mu\text{mol/s}$	8 LB Frames	389 W DC	1008 $\mu\text{mol/s}$	402-398 W	3.34-1.41 A	394-394 W	1.42-0.80 A
3-Bar	8" [20 cm]	24 W	189 $\mu\text{mol/s}$	2 LB Frames	146 W DC	378 $\mu\text{mol/s}$	154-151 W	1.30-0.62 A	159-158 W	0.60-0.41 A
3-Bar	8" [20 cm]	24 W	189 $\mu\text{mol/s}$	3 LB Frames	219 W DC	567 $\mu\text{mol/s}$	232-226 W	1.95-0.87 A	234-232 W	0.88-0.55 A
3-Bar	8" [20 cm]	24 W	189 $\mu\text{mol/s}$	4 LB Frames	292 W DC	756 $\mu\text{mol/s}$	309-302 W	2.60-1.12 A	310-306 W	1.15-0.68 A
3-Bar	8" [20 cm]	24 W	189 $\mu\text{mol/s}$	5 LB Frames	365 W DC	945 $\mu\text{mol/s}$	374-371 W	3.11-1.31 A	368-368 W	1.33-0.75 A
3-Bar	8" [20 cm]	24 W	189 $\mu\text{mol/s}$	6 LB Frames	438 W DC	1134 $\mu\text{mol/s}$	451-446 W	3.75-1.58 A	443-442 W	1.60-0.90 A
3-Bar	8" [20 cm]	24 W	189 $\mu\text{mol/s}$	7 LB Frames	511 W DC	1323 $\mu\text{mol/s}$	527-520 W	4.38-1.85 A	517-516 W	1.87-1.05 A
3-Bar	8" [20 cm]	24 W	189 $\mu\text{mol/s}$	8 LB Frames	584 W DC	1512 $\mu\text{mol/s}$	603-595 W	5.02-2.11 A	592-590 W	2.14-1.20 A
4-Bar	6" [15 cm]	24 W	252 $\mu\text{mol/s}$	2 LB Frames	195 W DC	504 $\mu\text{mol/s}$	216-214 W	1.84-0.91 A	208-206 W	0.78-0.50 A
4-Bar	6" [15 cm]	24 W	252 $\mu\text{mol/s}$	3 LB Frames	292 W DC	756 $\mu\text{mol/s}$	309-302 W	2.60-1.12 A	310-306 W	1.15-0.68 A
4-Bar	6" [15 cm]	24 W	252 $\mu\text{mol/s}$	4 LB Frames	389 W DC	1008 $\mu\text{mol/s}$	402-398 W	3.34-1.41 A	394-394 W	1.42-0.80 A
4-Bar	6" [15 cm]	24 W	252 $\mu\text{mol/s}$	5 LB Frames	487 W DC	1260 $\mu\text{mol/s}$	505-499 W	4.20-1.77 A	496-495 W	1.79-1.01 A
4-Bar	6" [15 cm]	24 W	252 $\mu\text{mol/s}$	6 LB Frames	584 W DC	1512 $\mu\text{mol/s}$	603-595 W	5.02-2.11 A	592-590 W	2.14-1.20 A
6-Bar	8" [20 cm]	24 W	378 $\mu\text{mol/s}$	1 LB Frame	146 W DC	378 $\mu\text{mol/s}$	154-151 W	1.30-0.62 A	159-158 W	0.60-0.41 A
6-Bar	8" [20 cm]	24 W	378 $\mu\text{mol/s}$	2 LB Frames	292 W DC	756 $\mu\text{mol/s}$	309-302 W	2.60-1.12 A	310-306 W	1.15-0.68 A
6-Bar	8" [20 cm]	24 W	378 $\mu\text{mol/s}$	3 LB Frames	438 W DC	1134 $\mu\text{mol/s}$	451-446 W	3.75-1.58 A	443-442 W	1.60-0.90 A
6-Bar	8" [20 cm]	24 W	378 $\mu\text{mol/s}$	4 LB Frames	584 W DC	1512 $\mu\text{mol/s}$	603-595 W	5.02-2.11 A	592-590 W	2.14-1.20 A
6-Bar	8" [20 cm]	49 W	724 $\mu\text{mol/s}$	1 LB Frame	292 W DC	724 $\mu\text{mol/s}$	309-302 W	2.60-1.12 A	310-306 W	1.15-0.68 A
6-Bar	8" [20 cm]	49 W	724 $\mu\text{mol/s}$	2 LB Frames	584 W DC	1447 $\mu\text{mol/s}$	603-595 W	5.02-2.11 A	592-590 W	2.14-1.20 A
8-Bar	6" [15 cm]	24 W	504 $\mu\text{mol/s}$	1 LB Frame	195 W DC	504 $\mu\text{mol/s}$	204-200 W	1.72-0.78 A	208-206 W	0.78-0.50 A
8-Bar	6" [15 cm]	24 W	504 $\mu\text{mol/s}$	2 LB Frames	389 W DC	1008 $\mu\text{mol/s}$	402-398 W	3.34-1.41 A	394-394 W	1.42-0.80 A
8-Bar	6" [15 cm]	49 W	965 $\mu\text{mol/s}$	1 LB Frame	389 W DC	965 $\mu\text{mol/s}$	603-595 W	5.02-2.11 A	592-590 W	2.14-1.20 A

Disclaimer: Performance values are from representative tests performed in accordance with industry standards listed. Actual application performance may vary due to component tolerances and installation, environmental, and field measurements conditions.

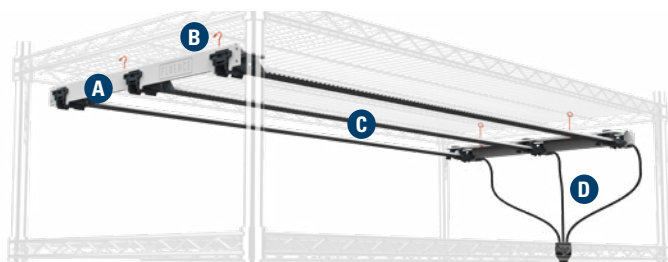

A Fixture Frames **B** Fixture Wire Hangers **C** Light Bar (Electrical System) **D** DC Splitter Cables (Electrical System)

RAZR Modular

Light Bar Fixtures

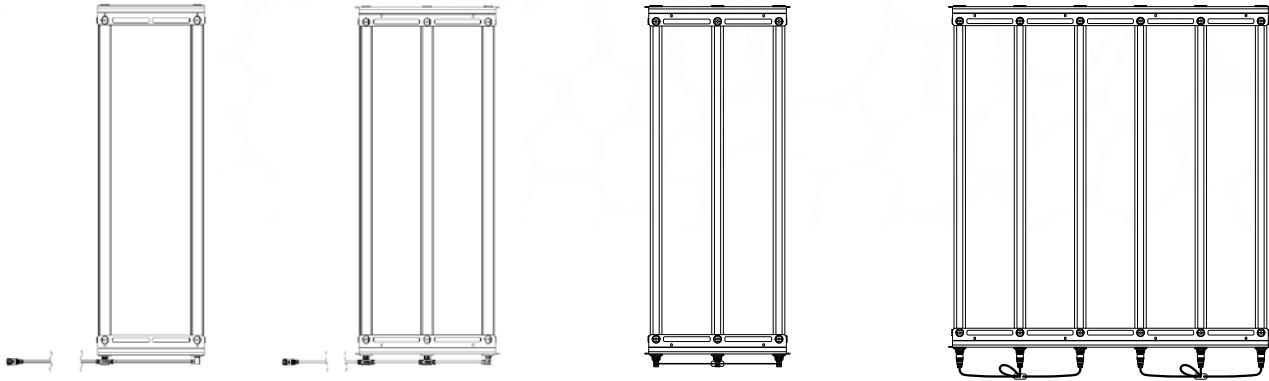

2R 2-Bar In-Line Cable

3R 3-Bar In-Line Cable

3A 3-Bar Right Angle Cable

6S 6-Bar Straight Cable

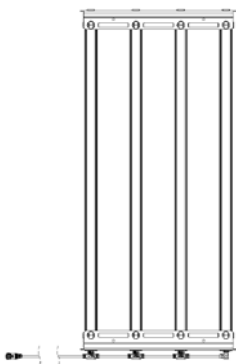

4R 4-Bar In-Line Cable

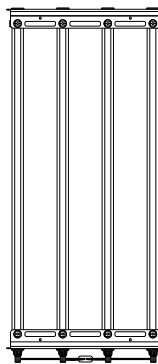

4A 4-Bar Right Angle Cable

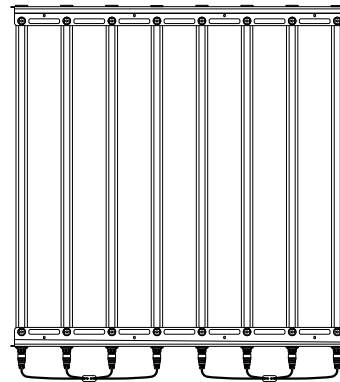

8S 8-Bar Straight Cable

LIGHT BAR FIXTURES ORDERING PART NUMBERS

Description	Regional Commercial Code	Ordering Part Number (12NC)
RAZRm, 3-Bar Fixture, 44", Enclosed, BW3, Right Angle Connector	RM-44-SL-BW3-3A-S	9124 017 02253
RAZRm, 4-Bar Fixture, 44", Enclosed, BW3, Right Angle Connector	RM-44-SL-BW3-4A-S	9124 017 02254
RAZRm, 6-Bar Fixture, 44", Enclosed, BW3, Straight Connector	RM-44-SL-BW3-6S-S	9124 017 02255
RAZRm, 8-Bar Fixture, 44", Enclosed, BW3, Straight Connector	RM-44-SL-BW3-8S-S	9124 017 02256
RAZRm, 2-Bar Fixture, 44", Enclosed, BW3, In-Line Cable	RM-44-SL-BW3-2R-S	9124 017 02257
RAZRm, 3-Bar Fixture, 44", Enclosed, BW3, In-Line Cable	RM-44-SL-BW3-3R-S	9124 017 02258
RAZRm, 4-Bar Fixture, 44", Enclosed, BW3, In-Line Cable	RM-44-SL-BW3-4R-S	9124 017 02259
RAZRm, 3-Bar Fixture, 48", Enclosed, BW3, Right Angle Connector	RM-48-SL-BW3-3A-S	9124 017 02260
RAZRm, 4-Bar Fixture, 48", Enclosed, BW3, Right Angle Connector	RM-48-SL-BW3-4A-S	9124 017 02261
RAZRm, 6-Bar Fixture, 48", Enclosed, BW3, Straight Connector	RM-48-SL-BW3-6S-S	9124 017 02262
RAZRm, 8-Bar Fixture, 48", Enclosed, BW3, Straight Connector	RM-48-SL-BW3-8S-S	9124 017 02263
RAZRm, 2-Bar Fixture, 48", Enclosed, BW3, In-Line Cable	RM-48-SL-BW3-2R-S	9124 017 02264
RAZRm, 3-Bar Fixture, 48", Enclosed, BW3, In-Line Cable	RM-48-SL-BW3-3R-S	9124 017 02265
RAZRm, 4-Bar Fixture, 48", Enclosed, BW3, In-Line Cable	RM-48-SL-BW3-4R-S	9124 017 02266
RAZRm, 3-Bar Fixture, 48", Enclosed, BW4, Right Angle Connector	RM-48-SL-BW4-3A-S	9124 017 02267
RAZRm, 4-Bar Fixture, 48", Enclosed, BW4, Right Angle Connector	RM-48-SL-BW4-4A-S	9124 017 02268
RAZRm, 6-Bar Fixture, 48", Enclosed, BW4, Straight Connector	RM-48-SL-BW4-6S-S	9124 017 02269
RAZRm, 8-Bar Fixture, 48", Enclosed, BW4, Straight Connector	RM-48-SL-BW4-8S-S	9124 017 02270
RAZRm, 2-Bar Fixture, 48", Enclosed, BW4, In-Line Cable	RM-48-SL-BW4-2R-S	9124 017 02271
RAZRm, 3-Bar Fixture, 48", Enclosed, BW4, In-Line Cable	RM-48-SL-BW4-3R-S	9124 017 02272
RAZRm, 4-Bar Fixture, 48", Enclosed, BW4, In-Line Cable	RM-48-SL-BW4-4R-S	9124 017 02273



Contact **FLUENCE**
 support@fluence-led.com
 www.fluence-led.com/RAZR

2-BAR POWER SUPPLIES ORDERING PART NUMBERS (120-277V)

System Type	Light Bar Spacing	Wattage/Bar	Number of Light Bar Frames/System	System DC Power	DC Current	Regional Commercial Code	Ordering PN 12NC Single Pack (-S)	Ordering PN 12NC Bulk Pack (-B)	Bulk Pack Pallet Quantity
2-Bar	12" [30 cm]	24 W	3 LB Frames	146 W DC	2.8 A	PLMG-V3B-320-028	9124 017 01918	9124 017 01992	30
2-Bar	12" [30 cm]	24 W	4 LB Frames	195 W DC	3.7 A	PLMG-V3B-320-037	9124 017 01917	9124 017 01991	30
2-Bar	12" [30 cm]	24 W	6 LB Frames	292 W DC	5.6 A	PLMG-V3B-320-056	9124 017 02021	9124 017 02022	30
2-Bar	12" [30 cm]	24 W	8 LB Frames	389 W DC	7.4 A	PLMG-V3A-600-074	9124 017 01915	9124 017 01989	24

2-BAR POWER SUPPLIES ORDERING PART NUMBERS (277-480V)

System Type	Light Bar Spacing	Wattage/Bar	Number of Light Bar Frames/System	System DC Power	DC Current	Regional Commercial Code	Ordering PN 12NC Single Pack (-S)	Ordering PN 12NC Bulk Pack (-B)	Bulk Pack Pallet Quantity
2-Bar	12" [30 cm]	24 W	3 LB Frames	146 W DC	2.8 A	PHMG-V3B-320-028	9124 017 02030	9124 017 02029	30
2-Bar	12" [30 cm]	24 W	4 LB Frames	195 W DC	3.7 A	PHMG-V3B-320-037	9124 017 02028	9124 017 02027	30
2-Bar	12" [30 cm]	24 W	6 LB Frames	292 W DC	5.6 A	PHMG-V3B-320-056	9124 017 01909	9124 017 01983	30
2-Bar	12" [30 cm]	24 W	8 LB Frames	389 W DC	7.4 A	PHMG-V2C-600-074	9124 017 01912	9124 017 01986	33

3-BAR POWER SUPPLIES ORDERING PART NUMBERS (120-277V)

System Type	Light Bar Spacing	Wattage/Bar	Number of Light Bar Frames/System	System DC Power	DC Current	Regional Commercial Code	Ordering PN 12NC Single Pack (-S)	Ordering PN 12NC Bulk Pack (-B)	Bulk Pack Pallet Quantity
3-Bar	8" [20 cm]	24 W	2 LB Frames	146 W DC	2.8 A	PLMG-V3B-320-028	9124 017 01918	9124 017 01992	30
3-Bar	8" [20 cm]	24 W	3 LB Frames	219 W DC	4.2 A	PLMG-V3B-320-042	9124 017 02023	9124 017 02024	30
3-Bar	8" [20 cm]	24 W	4 LB Frames	292 W DC	5.6 A	PLMG-V3B-320-056	9124 017 02021	9124 017 02022	30
3-Bar	8" [20 cm]	24 W	5 LB Frames	365 W DC	6.9 A	PLMG-V3A-600-069	9124 017 01916	9124 017 01990	24
3-Bar	8" [20 cm]	24 W	6 LB Frames	438 W DC	8.3 A	PLMG-V3A-600-083	9124 017 02015	9124 017 02016	24
3-Bar	8" [20 cm]	24 W	7 LB Frames	511 W DC	9.7 A	PLMG-V3A-600-097	9124 017 02013	9124 017 02014	24
3-Bar	8" [20 cm]	24 W	8 LB Frames	584 W DC	11.1 A	PLMG-V3A-600-111	9124 017 01914	9124 017 01988	24

3-BAR POWER SUPPLIES ORDERING PART NUMBERS (277-480V)

System Type	Light Bar Spacing	Wattage/Bar	Number of Light Bar Frames/System	System DC Power	DC Current	Regional Commercial Code	Ordering PN 12NC Single Pack (-S)	Ordering PN 12NC Bulk Pack (-B)	Bulk Pack Pallet Quantity
3-Bar	8" [20 cm]	24 W	2 LB Frames	146 W DC	2.8 A	PHMG-V3B-320-028	9124 017 02030	9124 017 02029	30
3-Bar	8" [20 cm]	24 W	3 LB Frames	219 W DC	4.2 A	PHMG-V3B-320-042	9124 017 02026	9124 017 02025	30
3-Bar	8" [20 cm]	24 W	4 LB Frames	292 W DC	5.6 A	PHMG-V3B-320-056	9124 017 01909	9124 017 01983	30
3-Bar	8" [20 cm]	24 W	5 LB Frames	365 W DC	6.9 A	PHMG-V2C-600-069	9124 017 01913	9124 017 01987	33
3-Bar	8" [20 cm]	24 W	6 LB Frames	438 W DC	8.3 A	PHMG-V2C-600-083	9124 017 01911	9124 017 01985	33
3-Bar	8" [20 cm]	24 W	7 LB Frames	511 W DC	9.7 A	PHMG-V2C-600-097	9124 017 02017	9124 017 02018	33
3-Bar	8" [20 cm]	24 W	8 LB Frames	584 W DC	11.1 A	PHMG-V2C-600-111	9124 017 01910	9124 017 01984	33

4-BAR POWER SUPPLIES ORDERING PART NUMBERS (120-277V)

System Type	Light Bar Spacing	Wattage/Bar	Number of Light Bar Frames/System	System DC Power	DC Current	Regional Commercial Code	Ordering PN 12NC Single Pack (-S)	Ordering PN 12NC Bulk Pack (-B)	Bulk Pack Pallet Quantity
4-Bar	6" [15 cm]	24 W	2 LB Frames	195 W DC	3.7 A	PLMG-V3B-320-037	9124 017 01917	9124 017 01991	30
4-Bar	6" [15 cm]	24 W	3 LB Frames	292 W DC	5.6 A	PLMG-V3B-320-056	9124 017 02021	9124 017 02022	30
4-Bar	6" [15 cm]	24 W	4 LB Frames	389 W DC	7.4 A	PLMG-V3A-600-074	9124 017 01915	9124 017 01989	24
4-Bar	6" [15 cm]	24 W	5 LB Frames	487 W DC	9.3 A	PLMG-V3A-600-093	9124 017 02001	9124 017 01999	24
4-Bar	6" [15 cm]	24 W	6 LB Frames	584 W DC	11.1 A	PLMG-V3A-600-111	9124 017 01914	9124 017 01988	24

4-BAR POWER SUPPLIES ORDERING PART NUMBERS (277-480V)

System Type	Light Bar Spacing	Wattage/Bar	Number of Light Bar Frames/System	System DC Power	DC Current	Regional Commercial Code	Ordering PN 12NC Single Pack (-S)	Ordering PN 12NC Bulk Pack (-B)	Bulk Pack Pallet Quantity
4-Bar	6" [15 cm]	24 W	2 LB Frames	195 W DC	3.7 A	PHMG-V3B-320-037	9124 017 02028	9124 017 02027	30
4-Bar	6" [15 cm]	24 W	3 LB Frames	292 W DC	5.6 A	PHMG-V3B-320-056	9124 017 01909	9124 017 01983	30
4-Bar	6" [15 cm]	24 W	4 LB Frames	389 W DC	7.4 A	PHMG-V2C-600-074	9124 017 01912	9124 017 01986	33
4-Bar	6" [15 cm]	24 W	5 LB Frames	487 W DC	9.3 A	PHMG-V2C-600-093	9124 017 02019	9124 017 02020	33
4-Bar	6" [15 cm]	24 W	6 LB Frames	584 W DC	11.1 A	PHMG-V2C-600-111	9124 017 01910	9124 017 01984	33

6-BAR POWER SUPPLIES ORDERING PART NUMBERS (120-277V)

System Type	Light Bar Spacing	Wattage/Bar	Number of Light Bar Frames/System	System DC Power	DC Current	Regional Commercial Code	Ordering PN 12NC Single Pack (-S)	Ordering PN 12NC Bulk Pack (-B)	Bulk Pack Pallet Quantity
6-Bar	8" [20 cm]	24 W	1 LB Frame	146 W DC	2.8 A	PLMG-V3B-320-028	9124 017 01918	9124 017 01992	30
6-Bar	8" [20 cm]	24 W	2 LB Frames	292 W DC	5.6 A	PLMG-V3B-320-056	9124 017 02021	9124 017 02022	30
6-Bar	8" [20 cm]	24 W	3 LB Frames	438 W DC	8.3 A	PLMG-V3A-600-083	9124 017 02015	9124 017 02016	24
6-Bar	8" [20 cm]	24 W	4 LB Frames	584 W DC	11.1 A	PLMG-V3A-600-111	9124 017 01914	9124 017 01988	24
6-Bar	8" [20 cm]	49 W	1 LB Frame	292 W DC	5.6 A	PLMG-V3B-320-056	9124 017 02021	9124 017 02022	30
6-Bar	8" [20 cm]	49 W	2 LB Frames	584 W DC	11.1 A	PLMG-V3A-600-111	9124 017 01914	9124 017 01988	24

6-BAR POWER SUPPLIES ORDERING PART NUMBERS (277-480V)

System Type	Light Bar Spacing	Wattage/Bar	Number of Light Bar Frames/System	System DC Power	DC Current	Regional Commercial Code	Ordering PN 12NC Single Pack (-S)	Ordering PN 12NC Bulk Pack (-B)	Bulk Pack Pallet Quantity
6-Bar	8" [20 cm]	24 W	1 LB Frame	146 W DC	2.8 A	PHMG-V3B-320-028	9124 017 02030	9124 017 02029	30
6-Bar	8" [20 cm]	24 W	2 LB Frames	292 W DC	5.6 A	PHMG-V3B-320-056	9124 017 01909	9124 017 01983	30
6-Bar	8" [20 cm]	24 W	3 LB Frames	438 W DC	8.3 A	PHMG-V2C-600-083	9124 017 01911	9124 017 01985	33
6-Bar	8" [20 cm]	24 W	4 LB Frames	584 W DC	11.1 A	PHMG-V2C-600-111	9124 017 01910	9124 017 01984	33
6-Bar	8" [20 cm]	49 W	1 LB Frame	292 W DC	5.6 A	PHMG-V3B-320-056	9124 017 01909	9124 017 01983	30
6-Bar	8" [20 cm]	49 W	2 LB Frames	584 W DC	11.1 A	PHMG-V2C-600-111	9124 017 01910	9124 017 01984	33

8-BAR POWER SUPPLIES ORDERING PART NUMBERS (120-277V)

System Type	Light Bar Spacing	Wattage/Bar	Number of Light Bar Frames/System	System DC Power	DC Current	Regional Commercial Code	Ordering PN 12NC Single Pack (-S)	Ordering PN 12NC Bulk Pack (-B)	Bulk Pack Pallet Quantity
8-Bar	6" [15 cm]	24 W	1 LB Frame	195 W DC	3.7 A	PLMG-V3B-320-037	9124 017 01917	9124 017 01991	30
8-Bar	6" [15 cm]	24 W	2 LB Frames	389 W DC	7.4 A	PLMG-V3A-600-074	9124 017 01915	9124 017 01989	24
8-Bar	6" [15 cm]	49 W	1 LB Frame	389 W DC	7.4 A	PLMG-V3A-600-074	9124 017 01915	9124 017 01989	24

8-BAR POWER SUPPLIES ORDERING PART NUMBERS (277-480V)

System Type	Light Bar Spacing	Wattage/Bar	Number of Light Bar Frames/System	System DC Power	DC Current	Regional Commercial Code	Ordering PN 12NC Single Pack (-S)	Ordering PN 12NC Bulk Pack (-B)	Bulk Pack Pallet Quantity
8-Bar	6" [15 cm]	24 W	1 LB Frame	195 W DC	3.7 A	PHMG-V3B-320-037	9124 017 02028	9124 017 02027	30
8-Bar	6" [15 cm]	24 W	2 LB Frames	389 W DC	7.4 A	PHMG-V2C-600-074	9124 017 01912	9124 017 01986	33
8-Bar	6" [15 cm]	49 W	1 LB Frame	389 W DC	7.4 A	PHMG-V2C-600-074	9124 017 01912	9124 017 01986	33



2-BAR DC CABLE EXTENSION ORDERING PART NUMBERS

System Type	Number of Light Bar Frames/System	Component Description	Quantities per System	Regional Commercial Code	Ordering PN 12NC Single Pack (-S)	Ordering PN 12NC Bulk Pack (-B)	Bulk Pack Pallet Quantity
2-Bar	3 LB Frames	4-Port Manifold Extension	1	CDG-RMU24PP9M1.4	9124 017 02125	9124 017 02141	10
		Dust Cap	1	RM-MDC	9124 017 02328	9124 017 02329	100
2-Bar	4 LB Frames	4-Port Manifold Extension	1	CDG-RMU24PP9M1.4	9124 017 02125	9124 017 02141	10
2-Bar	6 LB Frames	4-Port Manifold Extension	2	CDG-RMU24PP9M1.4	9124 017 02125	9124 017 02141	10
		Dust Cap	2	RM-MDC	9124 017 02328	9124 017 02329	100
		Manifold Splitter, 3FT	1	CDG-RMU2MSFP9M0.9	9124 017 02124	9124 017 02140	10
2-Bar	8 LB Frames	4-Port Manifold Extension	2	CDG-RMU24PP9M1.4	9124 017 02125	9124 017 02141	10
		Manifold Splitter, 3FT	1	CDG-RMU2MSFP9M0.9	9124 017 02124	9124 017 02140	10

3-BAR DC CABLE EXTENSION ORDERING PART NUMBERS

System Type	Number of Light Bar Frames/System	Component Description	Quantities per System	Regional Commercial Code	Ordering PN 12NC Single Pack (-S)	Ordering PN 12NC Bulk Pack (-B)	Bulk Pack Pallet Quantity
3-Bar	2 LB Frames	4-Port Manifold Extension	1	CDG-RMU24PP9M1.4	9124 017 02125	9124 017 02141	10
		Dust Cap	2	RM-MDC	9124 017 02328	9124 017 02329	100
3-Bar	3 LB Frames	4-Port Manifold Extension	1	CDG-RMU24PP9M1.4	9124 017 02125	9124 017 02141	10
		Dust Cap	1	RM-MDC	9124 017 02328	9124 017 02329	100
3-Bar	4 LB Frames	4-Port Manifold Extension	1	CDG-RMU24PP9M1.4	9124 017 02125	9124 017 02141	10
3-Bar	5 LB Frames	6-Port Manifold Extension	1	CDG-RMU26PP9M1.5	9124 017 02126	9124 017 02142	10
		Dust Cap	1	RM-MDC	9124 017 02328	9124 017 02329	100
3-Bar	6 LB Frames	6-Port Manifold Extension	1	CDG-RMU26PP9M1.5	9124 017 02126	9124 017 02142	10
3-Bar	7 LB Frames	8-Port Manifold Extension	1	CDG-RMU28PP9M0.9	9124 017 02127	9124 017 02143	10
		Dust Cap	1	RM-MDC	9124 017 02328	9124 017 02329	100
3-Bar	8 LB Frames	8-Port Manifold Extension	1	CDG-RMU28PP9M0.9	9124 017 02127	9124 017 02143	10

4-BAR DC CABLE EXTENSION ORDERING PART NUMBERS

System Type	Number of Light Bar Frames/System	Component Description	Quantities per System	Regional Commercial Code	Ordering PN 12NC Single Pack (-S)	Ordering PN 12NC Bulk Pack (-B)	Bulk Pack Pallet Quantity
4-Bar	2 LB Frames	4-Port Manifold Extension	1	CDG-RMU24PP9M1.4	9124 017 02125	9124 017 02141	10
		Dust Cap	2	RM-MDC	9124 017 02328	9124 017 02329	100
4-Bar	3 LB Frames	4-Port Manifold Extension	1	CDG-RMU24PP9M1.4	9124 017 02125	9124 017 02141	10
		Dust Cap	1	RM-MDC	9124 017 02328	9124 017 02329	100
4-Bar	4 LB Frames	4-Port Manifold Extension	1	CDG-RMU24PP9M1.4	9124 017 02125	9124 017 02141	10
4-Bar	5 LB Frames	6-Port Manifold Extension	1	CDG-RMU26PP9M1.5	9124 017 02126	9124 017 02142	10
		Dust Cap	1	RM-MDC	9124 017 02328	9124 017 02329	100
4-Bar	6 LB Frames	8-Port Manifold Extension	1	CDG-RMU28PP9M0.9	9124 017 02127	9124 017 02143	10

6-BAR DC CABLE EXTENSION ORDERING PART NUMBERS

System Type	Number of Light Bar Frames/System	Component Description	Quantities per System	Regional Commercial Code	Ordering PN 12NC Single Pack (-S)	Ordering PN 12NC Bulk Pack (-B)	Bulk Pack Pallet Quantity
6-Bar	1 LB Frame	4-Port Manifold Extension	1	CDG-RMU24PP9M1.4	9124 017 02125	9124 017 02141	10
		Dust Cap	2	RM-MDC	9124 017 02328	9124 017 02329	100
6-Bar	2 LB Frames	4-Port Manifold Extension	1	CDG-RMU24PP9M1.4	9124 017 02125	9124 017 02141	10
6-Bar	3 LB Frames	6-Port Manifold Extension	1	CDG-RMU26PP9M1.5	9124 017 02126	9124 017 02142	10
6-Bar	4 LB Frames	8-Port Manifold Extension	1	CDG-RMU28PP9M0.9	9124 017 02127	9124 017 02143	10

8-BAR DC CABLE EXTENSION ORDERING PART NUMBERS

System Type	Number of Light Bar Frames/System	Component Description	Quantities per System	Regional Commercial Code	Ordering PN 12NC Single Pack (-S)	Ordering PN 12NC Bulk Pack (-B)	Bulk Pack Pallet Quantity
8-Bar	1 LB Frame	4-Port Manifold Extension	1	CDG-RMU24PP9M1.4	9124 017 02125	9124 017 02141	10
8-Bar	2 LB Frames	4-Port Manifold Extension	1	CDG-RMU24PP9M1.4	9124 017 02125	9124 017 02141	10
		Dust Cap	2	RM-MDC	9124 017 02328	9124 017 02329	100



RAZR Modular

Light Bar Fixtures

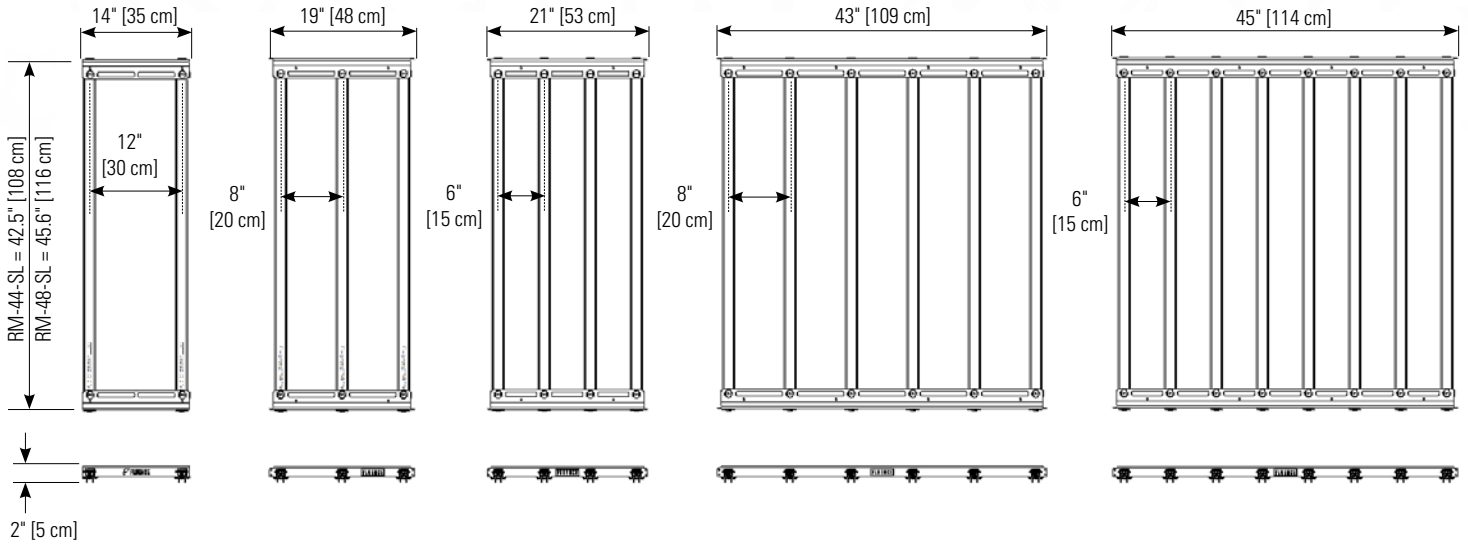

Weights:

44": 2.7 lbs [1,2 kg]	44": 4 lbs [1,8 kg]	44": 5.2 lbs [2,3 kg]	44": 8.4 lbs [3,8 kg]	44": 10.6 lbs [4,8 kg]
48": 2.8 lbs [1,3 kg]	48": 4.2 lbs [1,9 kg]	48": 5.4 lbs [2,4 kg]	48": 8.8 lbs [4,0 kg]	48": 11.1 lbs [5,0 kg]

POWER SUPPLY DIMENSIONS AND WEIGHT

Power Supply	Regional Commercial Code	Length	Width	Height	Weight
120-277V AC PSU 365/438/511/584 W DC	PLMG-V3A-600-xxx	12.9" [32,9 cm]	5.3" [13,4 cm]	2.6" [6,7 cm]	8.1 lb [3,7 kg]
277-480V AC PSU 365/438/511/584 W DC	PHMG-V2C-600-xxx	10" [25,4 cm]	6.4" [16,3 cm]	2.4" [6,3 cm]	7.5 lb [3,4 kg]
120-277 V AC PSU 146/219/292 W DC	PLMG-V3B-320-xxx	11.3" [28,8 cm]	4.3" [10,9 cm]	2.9" [7,3 cm]	5.8 lb [2,6 kg]
277-480V AC PSU 146/219/292 W DC	PHMG-V3B-320-xxx	11.3" [28,8 cm]	4.3" [10,9 cm]	2.9" [7,3 cm]	5.8 lb [2,6 kg]

POWER SUPPLY

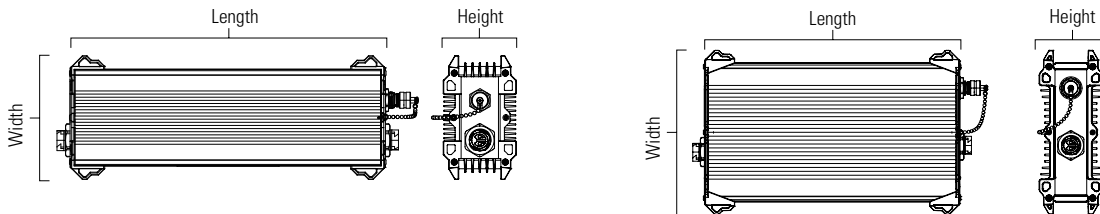

Contact **FLUENCE** @
support@fluence-led.com ✉
www.fluence-led.com/RAZR 🌐

RAZR Modular

Light Bar Fixtures



FIXTURE TO RACK MOUNTING ACCESSORIES

Mounting Accessories	Length	QTY per Fixtures	Regional Commercial Code	Ordering PN 12NC Single Pack
B1 Fixture Wire Hanger, Short - Baker's Rack	2" [5 cm]	1 Kit (4 pcs)	MR-RM-SH-XX-S	9124 017 02106
B2 Fixture Wire Hanger, Medium - PIPP Rack	4" [10 cm]	1 Kit (4 pcs)	MR-RM-MH-XX-S	9124 017 02107
B3 Fixture Wire Hanger, Long - Pallet Rack	7.5" [19 cm]	1 Kit (4 pcs)	MR-RM-LH-XX-S	9124 017 02108

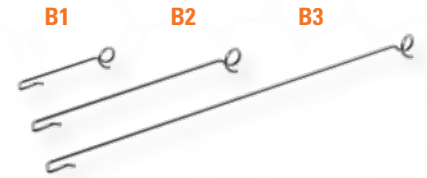

ACCESSORIES FOR POWER SUPPLY

Power Supply Mounting Hardware	PSU LVG 292 W DC 120-277 V AC	PSU LVG 584 W DC 120-277 V AC	PSU HVG 584 W DC 277-480 V AC	Regional Commercial Code	Ordering PN 12NC Single Pack (-S)	Ordering PN 12NC Bulk Pack (-B)	Bulk Pack Carton Quantity
PSU 320 W Power Supply Surface Mount Kit	1 Kit	N/A	N/A	MS-PS-MB-3V	9124 016 56290	9124 016 56012	10 Kits
PSU LVG 600 W Power Supply Surface Mount Kit	N/A	1 Kit	N/A	MS-PS-MB-LV	9124 016 56292	9124 016 56011	10 Kits
PSU HVG 600 W Power Supply Surface Mount Kit	N/A	N/A	1 Kit	MS-PS-MB-HV	9124 016 56291	9124 016 56284	10 Kits
Unistrut Wire Hanger (for Strut Width ≤ 1-5/8" / 45 mm)	1 Kit	1 Kit	1 Kit	MT-VR-US-XX	9124 016 56297	9124 016 55884	20 Kits
Pipe Wire Hanger (for Pipe Diameter ≤ 1-3/4" / 45 mm)	1 Kit	1 Kit	1 Kit	MT-VR-PI-XX	9124 016 56295	9124 016 55877	20 Kits
Square Wire Hanger (for Truss Width ≤ 2-3/4" / 70 mm)	1 Kit	1 Kit	1 Kit	MT-VR-SQ-X	9124 016 56296	9124 016 55897	20 Kits

AC Power Cable - AMERICAS (Power Supply to AC Line)	Quantity per Power Supply	Regional Commercial Code	Ordering PN 12NC Single Pack (S)	Ordering PN 12NC Bulk Pack (B)	Bulk Pack Carton Quantity
6-FT (1.83 m) AC Cable, NEMA 5-15P Plug, M19 Push Lock, Max 125 V AC	1 Pc	CAA-XXU3P9FN5P1.8	9124 017 01611	9124 016 88454	10 Pcs
6-FT (1.83 m) AC Cable, NEMA 6-15P Plug, M19 Push Lock, Max 250 V AC	1 Pc	CAA-XXU3P9FN6P1.8	9124 017 01613	9124 016 88456	10 Pcs
6-FT (1.83 m) AC Cable, NEMA L7-15P Plug, M19 Push Lock, Max 277 V AC	1 Pc	CAA-XXU3P9FL7P1.8	9124 017 01625	9124 016 55898	10 Pcs
6-FT (1.83 m) AC Cable, Pigtail, M19 Push Lock, Max 480 V AC	1 Pc	CAA-XXU3P9FL3X1.8	9124 017 01624	9124 016 55875	10 Pcs
15-FT (4.57 m) AC Cable, NEMA 5-15P Plug, M19 Push Lock, Max 125 V AC	1 Pc	CAA-XXU3P9FN5P4.6	9124 017 01612	9124 016 88455	5 Pcs
15-FT (4.57 m) AC Cable, NEMA 6-15P Plug, M19 Push Lock, Max 250 V AC	1 Pc	CAA-XXU3P9FN6P4.6	9124 017 01614	9124 016 88457	5 Pcs
15-FT (4.57 m) AC Cable, NEMA L7-15P Plug, M19 Push Lock, Max 277 V AC	1 Pc	CAA-XXU3P9FL7P4.6	9124 017 01626	9124 016 55899	5 Pcs
15-FT (4.57 m) AC Cable, Pigtail, M19 Push Lock, Max 480 V AC	1 Pc	CAA-XXU3P9FL3X4.6	9124 017 01610	9124 016 88461	5 Pcs
Wieland AC Connector Adapter for Power Supply, STW PVC, M19 Push Lock, 18-IN (0.46 m), Wieland Part #: 96.032.0053.1 (Male)	1 Pc	AAA-XXU3P9FWGM0.5	9124 016 56089	9124 016 56090	20 Pcs

DC Dimming Signal Cable - AMERICAS (Power Supply to Dimming Control)	Quantity per Power Supply	Regional Commercial Code	Ordering PN 12NC Single Pack (S)	Ordering PN 12NC Bulk Pack (B)	Bulk Pack Carton Quantity
11-IN (0.28 m) Dimming Signal Cable, Pigtail, M12 Connector	1 Pc	CCA-XXU3T2FL3X0.3	9124 017 01621	9124 016 55902	10 Pcs
5-FT (1.52 m) Dimming Signal Cable, Pigtail, M12 Connector	1 Pc	CCA-XXU3T2FL3X1.5	9124 017 01622	9124 016 55881	10 Pcs

AC Power Cable - INTERNATIONAL (Power Supply to AC Line)	Quantity per Power Supply	Regional Commercial Code	Ordering PN 12NC Single Pack (S)	Ordering PN 12NC Bulk Pack (B)	Bulk Pack Carton Quantity
1,83 m (6 FT) AC Cable, VDE, Schuko Type F7 Plug, M19 Push Lock, 230 V AC	1 Pc	CAE-XXV3P9FF7P1.8	9124 017 01628	9124 016 55901	10 Pcs
1,83 m (6 FT) AC Cable, VDE, Pigtail, M19 Push Lock (Not for CE Countries)	1 Pc	CAR-XXV3P9FL3X1.8	9124 017 01616	9124 016 88464	10 Pcs
4,57 m (15 FT) AC Cable, VDE, Schuko Type F7 Plug, M19 Push Lock, 230 V AC	1 Pc	CAE-XXV3P9FF7P4.6	9124 017 01615	9124 016 88463	5 Pcs
4,57 m (15 FT) AC Cable, VDE, Pigtail, M19 Push Lock (Not for CE Countries)	1 Pc	CAR-XXV3P9FL3X4.6	9124 017 01617	9124 016 88465	5 Pcs
70 cm (27,6 IN) AC Cable, Dca, Pigtail, M19 Push Lock (400V CE Application)	1 Pc	CAE-XXD3P9FL3X0.7	9124 017 01627	9124 016 55887	10 Pcs
80 cm (31,5 IN) AC Cable, Dca, Pigtail (Use with Adapter Cable) Wieland Connector Part #: 20i30F B2 ZR1S H GN02 (Female)	1 Pc	CAE-XXD3WGF3X0.8	9124 016 56106	9124 016 56107	10 Pcs
Wieland AC Connector Adapter for Power Supply, Dca Cable, M19 Push Lock, 20 cm (8 IN), Wieland Part #: RST20i3F S2 ZR1SVH GNO (Male)	1 Pc	AAE-XXD3P9FWGM0.2	9124 017 01609	9124 016 88466	10 Pcs
1,83 m (6 FT) AC Cable, VDE, SAA 3-Prong Plug, M19 Push Lock, Max 250 V AC (Australia and New Zealand)	1 Pc	CAZ-XXS3P9FTIP1.8	9124 017 01618	9124 016 88467	10 Pcs

DC Dimming Signal Cable - INTERNATIONAL (Power Supply to Dimming Control)	Quantity per Power Supply	Regional Commercial Code	Ordering PN 12NC Single Pack (S)	Ordering PN 12NC Bulk Pack (B)	Bulk Pack Carton Quantity
80 cm (31,5 IN) Dimming Signal Cable, Cca, Pigtail, M12 Connector	1 Pc	CCE-XXC3T2FL3X0.8	9124 017 01623	9124 016 55883	10 Pcs



Contact **FLUENCE**
 support@fluence-led.com
 www.fluence-led.com/RAZR